

AQUUPAR BAT



SAGITTER



SORGENTE LUMINOSA

7x10W led RGBW Full Color
 Vita media sorgente: > 50.000h
 Frequenza diodi led: > 400Hz flicker-free

OTTICA

Angolo di proiezione: 10°
 Luminosità: 1300lux @ 5m (full on)

SISTEMA COLORI

Sorgente LED RGBW Full color
 Possibilità cromatiche illimitate

EFFETTI

Dimmer lineare 0-100%
 Effetto strobo regolabile
 Macro colori selezionabili via DMX

CONTROLLO E PROGRAMMAZIONE

5 configurazioni DMX disponibili: 2/3/5/8/11 canali
 Funzione Key lock con password per blocco display
 Controllo segnale USITT DMX 512
 DMX wireless transceiver incorporato

Modalità Master/Slave

Modalità Static Color

Modalità automatiche con 15 programmi selezionabili da display con regolazione della velocità

Color mode con 50 macro colori e 11 macro bianco

Sistema di calibrazione del colore

Sistema di gestione della potenza

4 curve dimmer selezionabili

Funzione lampada emergenza

STRUTTURA E CORPO MOBILE

Struttura pressofusa in lega di alluminio 5052 ad alta resistenza alla corrosione

Display grafico LCD a colori

Vetro temperato frontale

Posizionamento "Light up" con regolazione inclinazione +/- 140°

Grado di protezione IP65

Connettori DMX XLR IN/OUT 3-poli XLR IP65

Raffreddamento per convezione senza ventole

Filtri magnetici inclusi: 40°- 60°x10°

ALIMENTAZIONE

Input Voltage: AC~100-240V, 50/60 Hz, per funzionamento normale e ricarica della batteria

Alimentatore switching universale

Batteria interna Li-Ion ricaricabile: 14,8VDC 12Ah

Durata batteria: ~ 4hrs (Full on - Boost power mode)

Durata batteria: ~ 12hrs (Color change - Boost power mode)

Ciclo di ricarica: ~ 8 ore (Proiettore spento)

Potenza massima: 70W @ 230VAC

Connettori Seetronic X Series IP65 IN/OUT

PESO E DIMENSIONI

Peso netto: 4,8 kg

Dimensioni: 240x200x270 mm

LIGHT SOURCE

7x10W led RGBW Full Color

LED lifespan: > 50.000h

LED refresh frequency: > 400Hz flicker-free

OPTIC SYSTEM

Beam Angle: 10°

Luminous flux: 1300lux @ 5m (full on)

COLOR SYSTEM

LED source RGBW Full color

Infinite chromatic possibilities

EFFECTS

Linear dimmer 0-100%

Adjustable strobe effect

Color macros selectable via DMX

CONTROL AND PROGRAMMING

5 DMX configurations available: 2/3/5/8/11 channels

Key lock password for display lock

Protocol USITT DMX 512

Built-in wireless DMX transceiver

Master/Slave mode

Static color mode

Auto mode with 15 programs selectable from the display, with speed adjustment

Color mode with 50 color macros and 11 white macros

Color calibration system

Power management system

4 different dimming curves available

Emergency light function

STRUCTURE AND CABINET

High corrosion resistance 5052 die cast aluminum housing

Color LCD display

Front tempered glass

"Light up" positioning with adjustable angle +/- 140°

IP65 rating

DMX 3-poles XLR IN/OUT IP65 connectors

Convection cooling system without fans

Frost filter included: 40°- 60°x10°

POWER SUPPLY

Input Voltage: AC~100-240V, 50/60 Hz for standard use and battery recharge

Switching power supply unit

Rechargeable internal Li-Ion battery: 14,8VDC 12Ah

Runtime battery: ~ 4 hrs (full ON - Boost power mode)

Runtime battery: ~ 12 hrs (Color change - Boost power mode)

Charging cycle: ~ 8 hrs (Projector turned off)

Max power: 70W @ 230VAC

Seetronic X Series IP65 Power Connectors IN/OUT

WEIGHT AND DIMENSIONS

Net weight: 4,8 kg

Dimensions: 240x200x270 mm



BATTERY POWERED PHOTOMETRIC DIAGRAMS

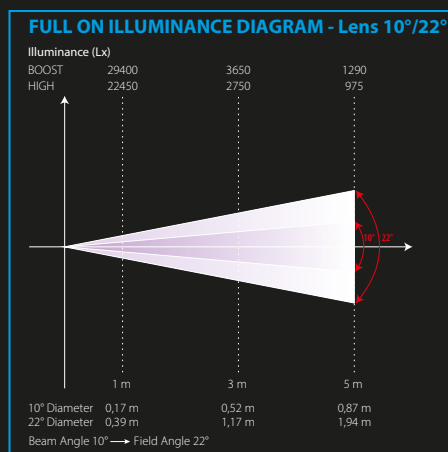
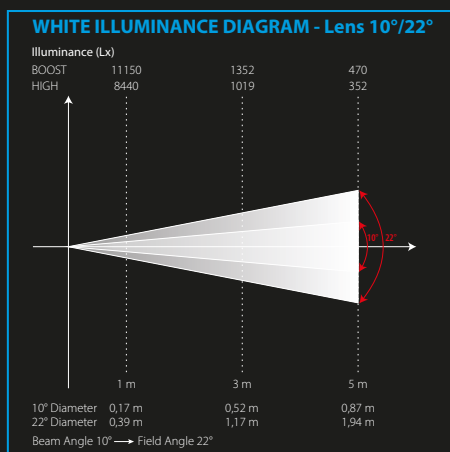
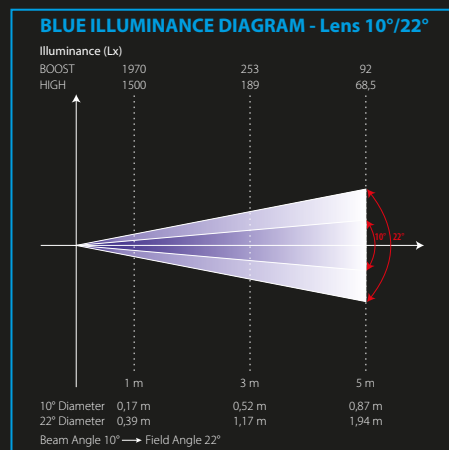
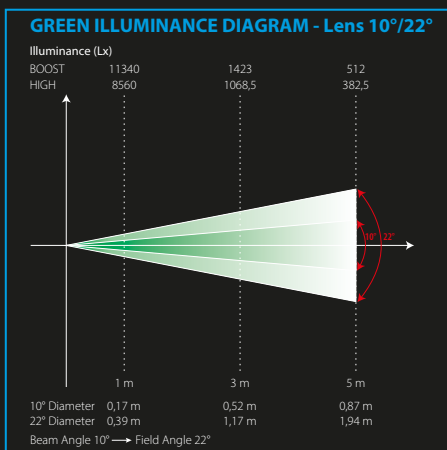
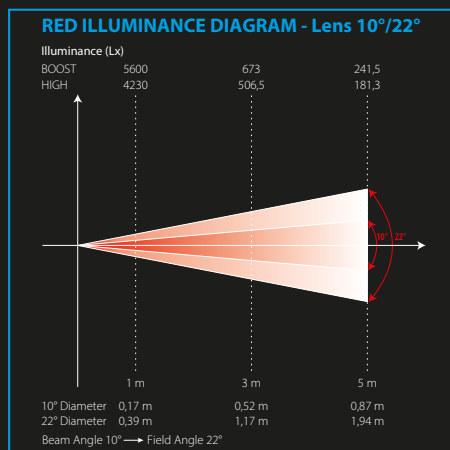

FLIGHTCASE

Flightcase realizzato in legno multistrato da 9mm rivestito da una superficie HEXA di colore nero. Può contenere fino a 6 proiettori AQU Par BAT, 12 filtri frost, 6 staffe ad omega per appendimento, 6 cavi di alimentazione. Il flightcase ha al suo interno un sistema di ricarica simultanea per 6 proiettori. Il posizionamento verticale del proiettore è stato scelto per dare all'operatore il massimo confort di presa tramite la maniglia posta sulla comoda staffa.

Dimensioni: 1030x495x380 mm

Flightcase made of 9mm plywood covered with a black HEXA surface. It can contain up to 6 AQU Par BAT projectors, 12 frost filters, 6 Omega bracket for hanging, 6 power cables. The flightcase has a simultaneous charging system for 6 projectors inside. The vertical positioning of the projector has been chosen to give the operator maximum grip comfort using the handle on the special bracket.

Dimensions: 1030x495x380 mm

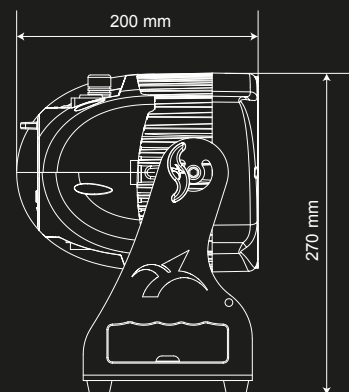
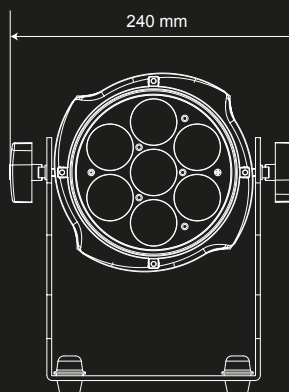
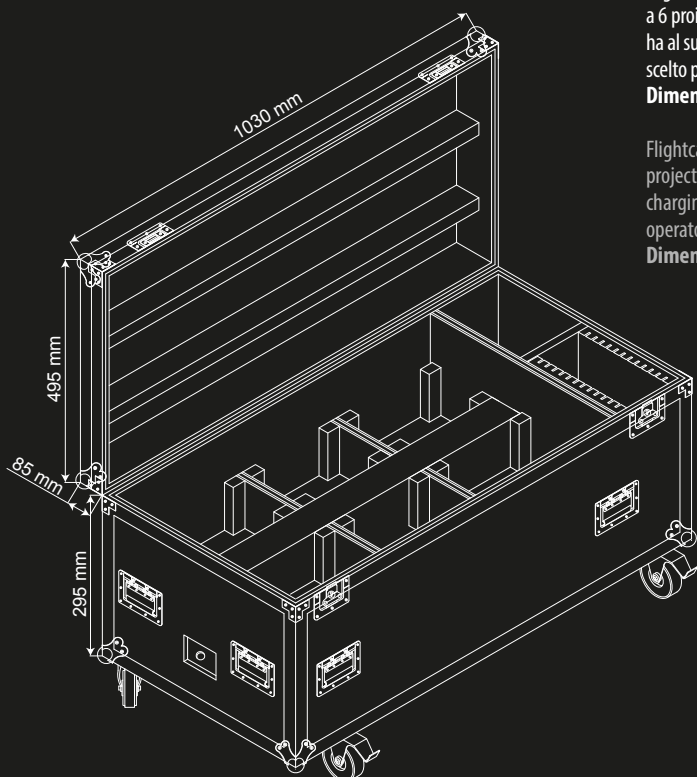



SAGITTER
is a brand of

PROEL SPA
(Worldwide Headquarters)
Via alla Ruenia, 37/43
64027 Sant'Omero (TE) - ITALY
Tel. +39 0861 81241
Fax +39 0861 887862
P.I. 00778590679
N.Reg.AEE IT 08020000002762

sagitter.com

SG AQUPBBROC23IE