



MOUNTS & ACCESSORIES



Cisco® Webex Board Mounting Kit

The Cisco® Webex Board Mounting Kit is designed specifically for the 55-inch, 70-inch or 85-inch Webex Board. The mounting kit makes it easy to install the Webex Board on the wall, or the mounting kit for the 55-inch and 70-inch Webex Board may replace the universal display mount on any AVTEQ mobile cart, stand or credenzas.

In addition, Webex Mounting Kit for the 55-inch and 70-inch Webex Board is integrated with select products and is available on AVTEQ's height adjustable DynamiQ™ 400 mount.

PART NUMBERS	WEBEX BOARD	DIMENSIONS
CSB-MOUNT	55-inch	28"H x 48"W x 1"D
CSB-MOUNT-70	70-inch	28"H x 62"W x 1"D
CSB-MOUNT-85	85-inch	43.31"H x 73.86"W x 8.35"D

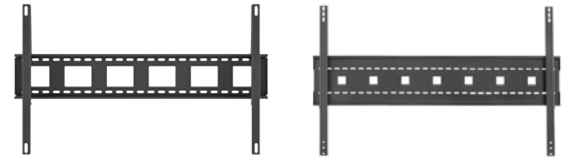

CSB-MOUNT

CSB-MOUNT-70

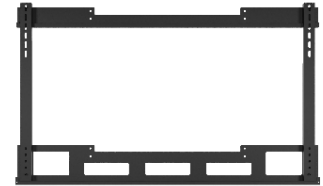

CSB-MOUNT-85

Cisco® Webex Room Kit Mounts

Room Kit Mounts are designed to install any Cisco® Webex Room Kit unit above or below a display on AVTEQ's display mounts, mobile stands and wall-mounted stands.

Available as a standalone bracket, or bundled with the AVTEQ UM-1 universal display mount for a single display up to 90°.

PART NUMBERS	WEBEX ROOM KIT	POSITION
CRK-ABV	Room Kit /Plus	Above
CRK-BLW	Room Kit /Plus	Below
CRK-MINI	Room Kit Mini	Above/below
CRK-ABV-BUNDLE	Includes UM-1 display mount	Above
CRK-BLW-BUNDLE	Includes UM-1 display mount	Below
CRK-MINI-BUNDLE	Includes UM-1 display mount	Above or below



CRK-ABV



CRK-MINI



CRK-BLW-BUNDLE

Cisco® Webex DX80 Mount Adapter

The DX80-ADAPTER provides an easy mounting system for the Cisco Webex DX80 on AVTEQ's VESA mount, or it can bolt to any 100×100 or 75×75 VESA mount. The DX80-ADAPTER offers a secure mounting solution for the 23" touch panel display, allowing the Webex DX80 to be installed on mobile carts, such as our TMP-200.

PART NUMBERS	DIMENSIONS
DX80-ADAPTER	4.44"H x 11"W x 1.07"D



Cisco® Wall Mounts

Cisco® Touch 10 Panel In-Wall Mount

The C10-WMP wall mount is designed specifically for the Cisco Touch 10 control panel. The in-wall box allows for a flush mounting of the Cisco unit for post or pre-construction.

PART NUMBER	DIMENSIONS
C10-WMP	15.25"W x 12" H x 1.8"D



Cisco® TelePresence SX20 Wall Mount

The SX20-WM is a mounting kit for Cisco's TelePresence SX20. It has a sleek glossy black powder coat finish, three-sided venting and cable management cover.

PART NUMBER	DIMENSIONS
SX20-WM	12"W x 7.25" H x 1.62"D



Poly® Wall Mounts

Polycom® RealPresence Touch Interface Panel Wall Mount

The P10-WMP wall mount is specifically designed for the Poly RealPresence Touch Interface panel. The in-wall box allows for a flush mounting of the Poly unit for post or pre-construction. The P10-WMP unit is available in glossy white finish.

PART NUMBER	DIMENSIONS WALL BOX	DIMENSIONS FRONT PLATE
P10-WMP	11.179"W x 9.75"H x 2.125"D	3.25"W x 10.25"H x 1"D

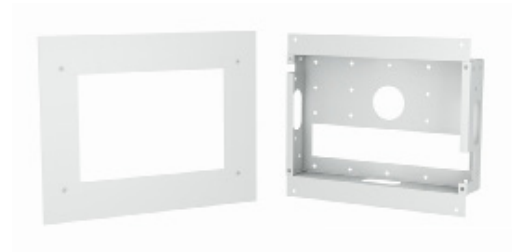

Polycom® Group Series 300/500 Wall Mount

The GROUP-WM wall mounting kit is specifically designed for Poly's Group Series 300/500. It has a sleek glossy black powder coat finish, three-sided venting and cable management cover.

PART NUMBER	DIMENSIONS
GROUP-WM	11"W x 5" H x 1.4"D



Camera Shelves

The optional Camera Shelves support the Polycom® Eagle Eye, Cisco® Precision HD or LifeSize® HD videoconferencing cameras.

- Mounts to a single gang or dual gang wall box or straight to wall
- 5 degree tilt on camera platform
- Gloss black finish

PART NUMBERS	WALL BOX	CAMERA TYPE
CS-1G-TBPLCM	Single gang	Cisco Precision HD or Polycom Eagle Eye cameras
CS-2G-TBPLCM	Dual gang	
CS-1G-LS	Single gang	Lifesize camera
CS-2G-LS	Dual gang	
WMS-EED		Polycom Eagle Eye Director



CS-1G-LS



WMS-EED

Codec Rack Shelf

Our Custom Rack Shelves for LifeSize® and Poly® codecs are compatible with the RPS-1000SE, RPS-1000LE, RPS-800L/S and the GMP series.

PART NUMBERS	CODEC
CRS-PLCM-G500	Polycom Group 300/500
CRS-LS-TEAM	Lifesize Team 220/200
CRS-LS-ROOM	Lifesize Room 220/200
CRS-LS-ICON	Lifesize Icon 600



CRS-PLCM-G500



CRS-LS-TEAM



CRS-LS-ROOM

Polycom® Studio Mount Bracket

The POLY-STUDIO-BRK is designed to install the Polycom® Studio USB video bar above or below a display on AVTEQ's display mounts, mobile stands and wall-mounted stands.

PART NUMBERS	DIMENSIONS
POLY-STUDIO-BRK	14.93"H x 6"W x 0.60"D



Lifesize® Icon 300™ Mount Bracket

The LS-ICON300-BRK is designed to install the Lifesize® Icon 300™ video camera above or below a display on AVTEQ's display mounts, mobile stands and wall-mounted stands.

PART NUMBERS	DIMENSIONS
LS-ICON300-BRK	9.85"H x 6"W x 0.60"D



Display Mounts

Universal Display Mount

The adjustable Universal Display Mount is a low-profile wall mount designed for a single display up to 90" or dual 70" displays. The low-profile design securely mounts the display(s) 2" from the wall and offers a 15 degree titling option.

PART NUMBERS	DISPLAY SIZE	TILT	DIMENSIONS
UM-1	Single display up to 90"		27"W x 9"H x 1"D
UM-1T	Single display up to 70" 400 x 400 VESA max	15-degree	
UM-2	Dual displays up to 70"		

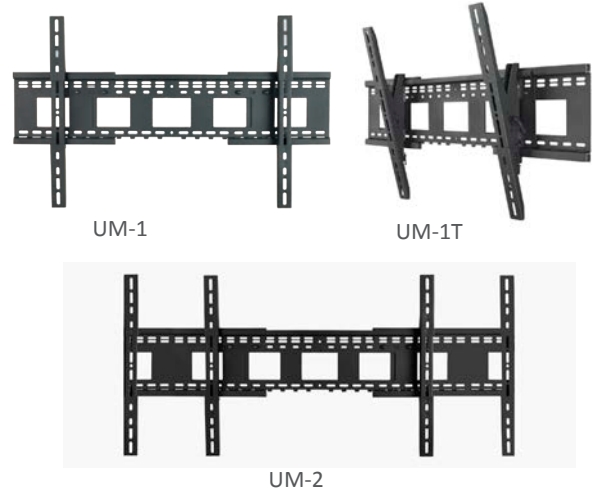

Wall Display Mounts

PS-100 display mount is designed to mount video conferencing equipment and either a single or dual flat screens to the wall. The PS-100 includes top or adjustable centered camera shelf and a bottom codec shelf.

PART NUMBERS	CODEC
PS-100S	90" single display
PS-100L	80" dual displays
PS-100-CTR	80" dual displays, adjustable center camera shelf

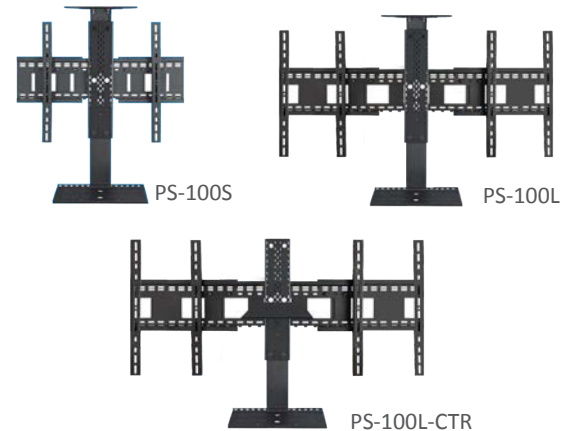

Low-Profile Wall Display Mount

The LED-1 is a low-profile wall mount LED single displays from 40" to 85". Mounting system includes a bubble level for best installation results. Mounting hardware included.

PART NUMBER	LOAD CAPACITY	DIMENSIONS
LED-1	165 lbs	36"W x 8"H x 0.5"D

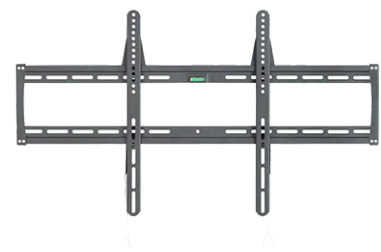

Display Mount Accessory

Securely mount a single display up to 65" or dual 55" displays on an AVTEQ cart or an existing piece of furniture without using the screen manufacturer's stand. Includes an integrated adjustable height camera shelf and two single gang knockouts on sides.

PART NUMBER	DIMENSIONS
TT-1	27.5"H x 32"W x 10"D
TT-2	27.5"H x 78"W x 10"D

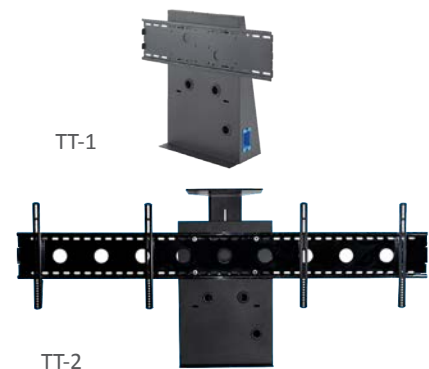

Apple® iPad® Display Mounts

iPad® Holder for VESA Mount

The AVTEQ iPad® Holder for VESA Mounts is a high-quality, heavy-duty tablet mount that is compatible with Apple iPads (approximately 9" to 10.5" screen size) including the 10.5-inch iPad Pro, iPad Air 2 and iPad Air, and the iPad 4, 3, and 2.

This mount is designed to be used with a universal VESA mount (100x100) and installed on the wall, desktop, or mobile display cart. The front plate provides maximum viewing of the iPad screen, camera and home button. The all-steel construction securely holds the iPad in place.



PART NUMBERS	OUTSIDE DIMENSIONS	INSIDE DIMENSIONS
IPAD-MOUNT	8.9"H x 11.4"W x 0.9"D	7.4"H x 9.9"W

Height Adjustable Display Mounts

DynamiQ™ 400

The DynamiQ™ 400 is a spring-weighted, height adjustable mount that allows the display to easily glide up and down with an effortless touch. This display supports a single display up to 198 lbs. The DynamiQ 400 also supports both the 55" and 70" Cisco Webex Board.

PART NUMBERS	DISPLAY	DIMENSIONS
AVT-BB400-40	Up to 83.6 lbs	22"W x 23.6" H x 2.9"D
AVT-BB400-70	83.6 - 145 lbs	
AVT-BB400-90	145.2 - 198 lbs	
AVT-BB-CSB55	55" Cisco Webex Board	
AVT-BB-CSB70	70" Cisco Webex Board	



DynamiQ™ 650

The DynamiQ™ 650 is the perfect height adjustable mount to move your large interactive touch screen displays up and down. This mechanical wall lift has a weight capacity up to 362 lbs in a compact design that will be hidden behind the screen. Interface brackets for all screen sizes, a floor support and a mobile frame are available as accessories.

PART NUMBERS	DISPLAY WEIGHT	DIMENSIONS
AVT-BB650-80	75-154.3 lbs	36.4"W x 41.6" H x 6.25"D
VT-BB650-130	147.7-280 lbs	
AVT-BB650-180	207.2-372.6 lbs	



Camera Shelf

The PS-50 video conferencing camera shelf is designed to be positioned vertically between dual displays on AVTEQ's carts and wall mounts to achieve an eye-to-eye perspective. Camera shelf may be positioned below displays on RPS and GMP series carts mounted with a 50" or smaller displays or will work on wall mounted displays.

PART NUMBER

PS-50



Standard Accessory Shelf

The optional 12.5" deep accessory shelf is compatible with AVTEQ's RPS-1000S/L, RPS-800S/L, the GMP series, GM series and TMP series mobile carts and credenzas.

PART NUMBER

US-1



Accessory Shelf for RPS-200

The optional 19" accessory shelf is compatible with AVTEQ's RPS-200 mobile cart.

PART NUMBER

RPS-AS2



Accessory Shelf for RPS-200 & RPS-400

The optional 14" accessory shelf is compatible with AVTEQ's RPS-200 and RPS-400 mobile carts.

PART NUMBER

RPS-AS4



Accessory Shelf for RPS-500

The optional 19" accessory shelf is compatible with AVTEQ's RPS-500 mobile carts.

PART NUMBER

RPS-AS5



AmpliVox® Power Speaker Module

The PSM-200 AmpliVox power speaker module can be installed on select AVTEQ mobile carts and floor stands. The unit is pre-installed if included with the original order.

PART NUMBER

PSM-200



6" Heavy Duty Casters

Set of four 6" heavy duty, single wheel casters, two locking. Casters are compatible with the following AVTEQ mobile carts: RPS-500, RPS-400, RPS-800, RPS-1000, RPX, plus the GM, GMP and TMP series.



PART NUMBER

HDC-6

Furniture Accessories

Sliding, Rotating Rack

The SR-12 additional sliding rotating rack is designed specifically for our 2-Bay and 3-Bay technology credenzas.



PART NUMBER

PSM-200

Credenza Fan Kit

Rack-mounted fan kit for 2-Bay and 3-Bay Credenzas. Kit comes preinstalled when ordering the credenza and includes thermal cord with in-line thermostat. Auto-on feature when ambient temp is 86° and off when 72°.



PART NUMBER

RACK FAN KIT

Rack Mount Bracket

The optional 2RU Rack Mount Bracket installs under a desk or table.



PART NUMBER

RMB

Rack Mounted Surge Protector

Rack mounted 9-port surge protector with 12-ft power cord.



PART NUMBER

RCK-PWR



Call 800.285.8315 or visit AVTEQ.net

 facebook.com/avteq  twitter.com/avteqinc  youtube.com/avteq  linkedin.com/avteqinc