



KRAMER ELECTRONICS LTD.

# USER MANUAL

MODEL:

**Galil 4-C**  
Closed-back Ceiling Speaker



## Galil 4-C Quick Start Guide

This guide helps you install and use your product for the first time. For more detailed information, go to <http://bit.ly/k-prod-downloads> to download the latest manual or scan the QR code on the left.

### Step 1: Check what's in the box

- Galil 4-C Closed-back Ceiling Speakers
- Ceiling mounting kit
- Cutout template
- Installation bracket
- 1 Quick start guide

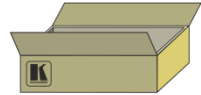

### Step 2: Choose the best location

Ideally, locate the speakers above the main listening area. Before doing so, be sure that:

- The desired location is free of obstructions, such as electric piping, AC ducts or water lines, and so on
- There is enough space behind the mounting surface for the speakers
- The rear side of the speakers is not blocked by wall studs or other objects

### Step 3: Install the speakers

To install the speakers:

- Cut the ceiling tile
- Place the C-ring over the hole and set the C-ring tabs parallel to the tile edges
- Place the tile rails on the tile and snap them into the two tabs on the C-ring and tighten with screws
- Connect the speaker wires (parallel or daisy-chain)
- Push the speaker into the ceiling hole and tighten the mounting tabs
- Secure speaker by connecting the speaker support ring to a secure anchor point
- Adjust the tap setting and then install the grille

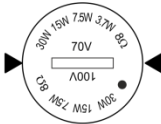

For best results, we recommend that you always use Kramer high-performance cables to connect AV equipment to your speakers

Always switch OFF the power on each device before connecting it to your Speakers.

#### PARALLEL WIRING

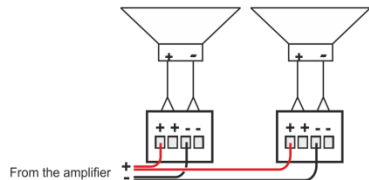

#### DAISY CHAIN WIRING

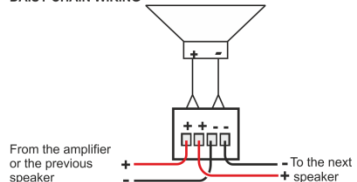

# Contents

<b>1</b>	<b>Introduction</b>	<b>1</b>
<b>2</b>	<b>Getting Started</b>	<b>2</b>
2.1	Achieving the Best Performance	2
2.2	Recycling Kramer Products	3
<b>3</b>	<b>Overview</b>	<b>4</b>
<b>4</b>	<b>Your Galil 4-C Closed-back Ceiling Speaker</b>	<b>5</b>
<b>5</b>	<b>Installing the Galil 4-C</b>	<b>7</b>
5.1	Choosing the Best Location	7
5.2	Cutting the Ceiling Tile	7
5.3	Mounting the Galil 4-C	8
5.4	Setting up an Array Installation	11
5.5	Painting the Speaker	14
<b>6</b>	<b>Technical Specifications</b>	<b>15</b>

# Figures

Figure 1:	Galil 4-C Closed-back Ceiling Speaker in a Boardroom Setup	4
Figure 2:	Galil 4-C Closed-back Ceiling Speaker	5
Figure 3:	Closed-back Ceiling Speaker Schematic Diagram	6
Figure 4:	Mounting the Galil 4-C Closed-back Ceiling Speaker	9
Figure 5:	Plugging and Securing the Cable	10
Figure 6:	Tighten the Mounting Tabs	10
Figure 7:	Adjust Tap Selector	11
Figure 8:	Square Layout	12
Figure 9:	Hexagonal Layout	12
Figure 10:	Square Layout Parallel Wiring	13

---

# 1 Introduction

Welcome to Kramer Electronics! Since 1981, Kramer Electronics has been providing a world of unique, creative, and affordable solutions to the vast range of problems that confront video, audio, presentation, and broadcasting professionals on a daily basis. In recent years, we have redesigned and upgraded most of our line, making the best even better!

Our 1,000-plus different models now appear in 14 groups that are clearly defined by function: GROUP 1: Distribution Amplifiers; GROUP 2: Switchers and Routers; GROUP 3: Control Systems; GROUP 4: Format/Standards Converters; GROUP 5: Range Extenders and Repeaters; GROUP 6: Specialty AV Products; GROUP 7: Scan Converters and Scalers; GROUP 8: Cables and Connectors; GROUP 9: Room Connectivity; GROUP 10: Accessories and Rack Adapters; GROUP 11: Sierra Video Products; GROUP 12: Digital Signage; GROUP 13: Audio; and GROUP 14: Collaboration.

Congratulations on purchasing your Kramer **Galil 4-C** Closed-back Ceiling Speaker, which are ideal for the following typical applications:

- Restaurants and cafes
- Boutiques and shops
- Boardrooms and meeting rooms
- Classrooms and lecture venues



**Galil 4-C** is designed for indoor dry locations and is suitable for use in air handling spaces (plenum spaces).

---

## 2 Getting Started

We recommend that you:

- Unpack the equipment carefully and save the original box and packaging materials for possible future shipment
- Review the contents of this user manual



Go to [http://www.kramerelectronics.com/support/product\\_downloads.asp](http://www.kramerelectronics.com/support/product_downloads.asp) to check for up-to-date user manuals, application programs, and to check if firmware upgrades are available (where appropriate).

### 2.1 Achieving the Best Performance

To achieve the best performance:

- Use only good quality connection cables (we recommend Kramer high-performance, high-resolution cables) to avoid interference, deterioration in signal quality due to poor matching, and elevated noise levels (often associated with low quality cables)
- Do not secure the cables in tight bundles or roll the slack into tight coils
- Avoid interference from neighboring electrical appliances that may adversely influence signal quality
- Position your Kramer Speakers away from moisture, excessive sunlight and dust



This equipment is to be used only inside a building. It may only be connected to other equipment that is installed inside a building.



Do not open the housing of the speaker; doing so may reduce the quality of the sound.



**UL2043** – Fire Test for Heat and Visible Smoke Release for Discrete Products and their Accessories Installed in Air-Handling Spaces.

## 2.2 Recycling Kramer Products

The Waste Electrical and Electronic Equipment (WEEE) Directive 2002/96/EC aims to reduce the amount of WEEE sent for disposal to landfill or incineration by requiring it to be collected and recycled. To comply with the WEEE Directive, Kramer Electronics has made arrangements with the European Advanced Recycling Network (EARN) and will cover any costs of treatment, recycling and recovery of waste Kramer Electronics branded equipment on arrival at the EARN facility. For details of Kramer's recycling arrangements in your particular country go to our recycling pages at <http://www.kramerelectronics.com/support/recycling/>.

### 3 Overview

The **Galil 4-C** Closed-back Ceiling Speaker consists of a pair of high performance closed back speakers. Mount your **Galil 4-C** speakers to the ceiling in one of two ways: either directly onto the ceiling or, for added protection, secure the speakers safely, using our ceiling mounting kit that is provided free (see [Section 5.3](#)).

The **Galil 4-C** speakers feature a multi-tap power transformer for selecting 8Ω (bypassing the transformer) or 70V/100V power settings that are suitable for an array installation.

[Figure 1](#) shows an example of how the **Galil 4-C** Closed-back Ceiling Speaker can be installed in a boardroom setup:

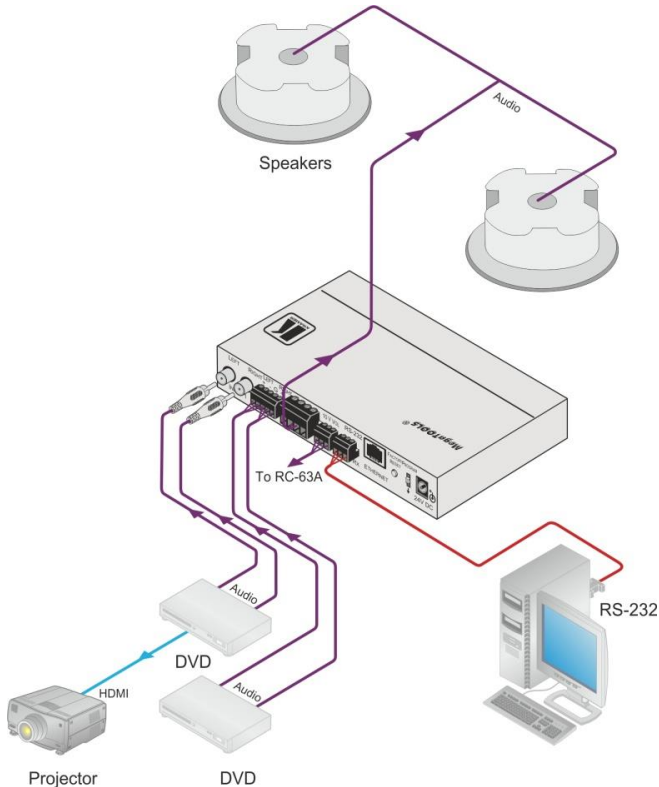

Figure 1: Galil 4-C Closed-back Ceiling Speaker in a Boardroom Setup

## 4 Your Galil 4-C Closed-back Ceiling Speaker

Figure 2 defines the Galil 4-C.

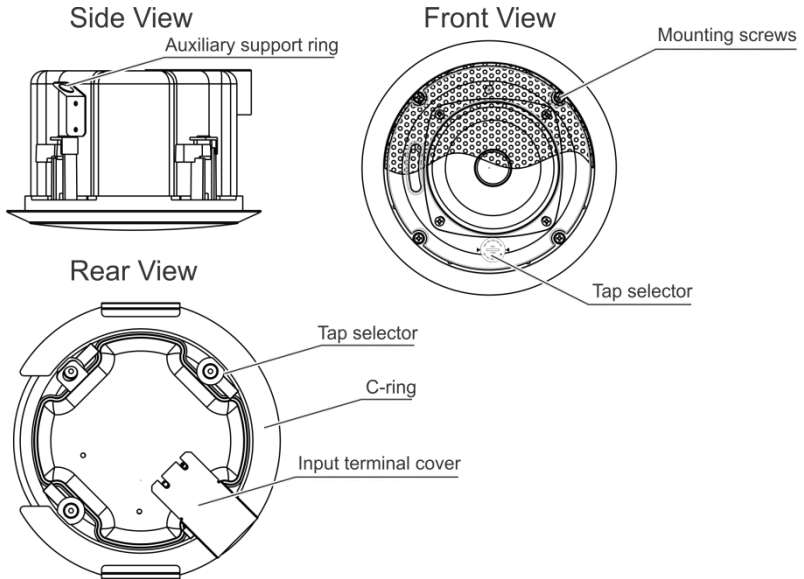

Figure 2: Galil 4-C Closed-back Ceiling Speaker

The following table defines the Closed-back Ceiling speaker hardware items (per speaker pair) for each model in the series:

Description					
A pair of ceiling speakers (one shown)		Two grilles (one shown)		Cutout template	

This table defines the ceiling mounting kit items:

Four support ring screws		Two ceiling support rings (C-ring) – one shown		Two pairs of tile rails – one of a pair shown	
--------------------------	--	--	--	---	--



Each Closed-back Ceiling speaker is supported by a C-ring and two tile rails. The tile rails prevent the speakers from falling if the tile itself comes out or falls apart, as their ends catch onto the T-grid. When mounting onto the ceiling tiles, use both supports. When mounting onto a sheetrock ceiling, the C-ring alone is used to reinforce the ceiling material.



Be sure that the tiles can support the speaker. Smaller sized tiles or fiberglass-type tiles cannot support the weight of the speakers. When this is the case, the speakers will need additional support.

[Figure 3](#) shows a schematic diagram of the Closed-back ceiling speaker:

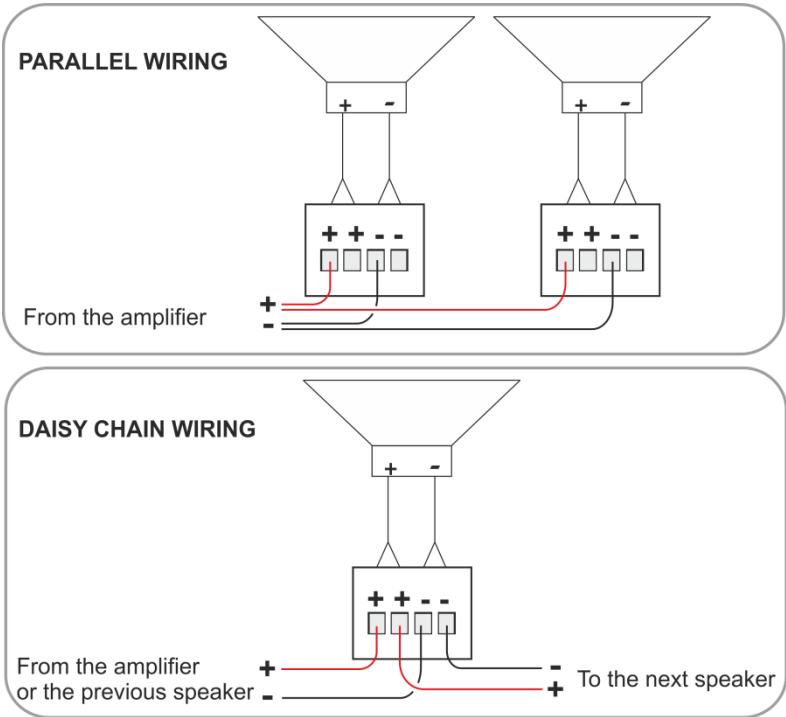

Figure 3: Closed-back Ceiling Speaker Schematic Diagram

---

## 5 Installing the Galil 4-C

This section explains how to install the **Galil 4-C** closed-back ceiling speakers, that is:

- Choosing the best place to locate your speakers (see [Section 5.1](#))
- Cutting the ceiling tile (see [Section 5.2](#))
- Mounting the speakers (see [Section 5.3](#))
- Setting up an array installation (see [Section 5.4](#))
- Painting the speakers (see [Section 5.5](#))

### 5.1 Choosing the Best Location

Ideally, locate the speakers above the main listening area. Before doing so, be sure that:

- The desired location is free of obstructions, such as electrical piping, AC ducts or water lines, and so on
- There is enough space behind the mounting surface for the speakers
- The rear side of the speaker is not blocked by wall studs or other objects

### 5.2 Cutting the Ceiling Tile

To cut the ceiling tile, do the following:

1. Remove the circle in the supplied template.  
Keep this template for later use as a mask, as you may want to paint the speakers (see [Section 5.5](#))
2. Mark the opening in the correct location by tracing the hole in the template.
3. Cut out the hole according to the template or with a circular cutter set to the appropriate cutout size.  
Initially, you can cut a smaller area inside the marked hole just to be sure that the space above the speakers is clear

4. Route the wiring from the amplifier to the speakers' cutout holes, taking care not to place them next to electrical wires or at least at a distance of about two feet from an AC line.



Do not nail or staple the speaker wires.

If you are mounting the speakers onto a ceiling tile, remove the ceiling tiles where you plan to install the speakers. Use the template to trace and then cutout the speaker hole over an empty box.

The closed-back ceiling speakers are supported by the ceiling mounting kit (two C-rings and two pairs of tile rails; the tile rails prevent the speakers from falling if the tile itself comes out or falls apart, as their ends catch onto the T-grid). When mounting onto the ceiling tiles, use both supports.



Be sure that the tiles can support the speaker. Smaller sized tiles or fiberglass-type tiles cannot support the weight of the speakers. When this is the case, the speakers will need additional support.

When mounting onto a sheetrock ceiling, the C-ring alone is used to reinforce the ceiling material.

## 5.3 Mounting the Galil 4-C

To mount the closed-back ceiling speakers, do the following:

1. Place the C-ring over the hole cut in the ceiling tile (on the "ceiling" side). Place it around the hole so that the tabs are located in parallel to the tile edges.

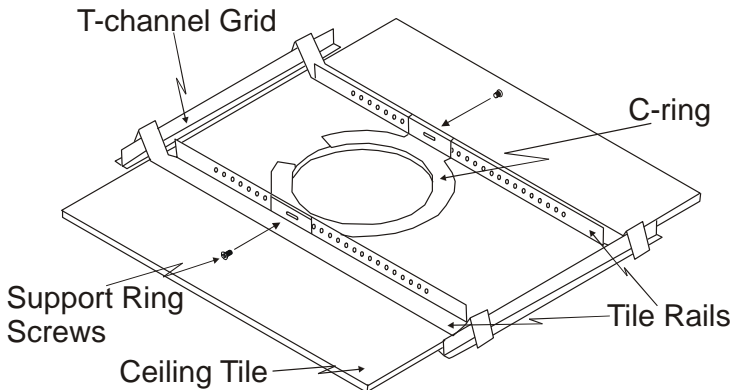

Figure 4: Mounting the Galil 4-C Closed-back Ceiling Speaker

2. Place the tile rails on the tile and snap them into the two tabs on the C-ring. Align the rails so that the ends extend over the T-channel grid.
3. Insert a screw through each tab on the C-ring to secure the rails.
4. Connect the speaker wires to the appropriate connector terminals:
  - PIN 1 and PIN 2 are connected internally and are positive (+)
  - PIN 3 and PIN 4 are connected internally and are negative (-)

Screw the hold-down screws on the connector until tight, using a small screwdriver.

You can connect the speakers in the two following possible layouts:

- **Wiring in parallel:** connect the amplifier directly to each of the speakers. When one input connector is removed, subsequent speakers will remain connected (see [Figure 3](#))
  - **Daisy-chaining:** connect the wire pair (+ and -) of the speaker to the subsequent speaker + and -. When one input connector is removed, subsequent speakers will be disconnected (see [Figure 3](#))
5. Plug the connector into the socket (see [Figure 5](#)).
  6. Run the wires through the opening in the input terminal cover and then connect to the speaker terminal block connector.

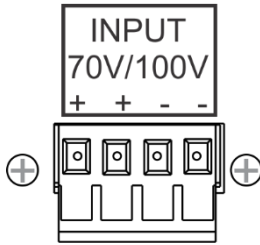

Figure 5: Plugging and Securing the Cable

7. Push the speaker into the ceiling hole until the front baffle rim is leveled with the ceiling.
8. Tighten the mounting tabs by turning the screw counter clockwise (see [Figure 6](#)).

Turning one quarter of a circle rotates the tab outwards; after that the screw is turned to tighten the tabs to the rear side of the ceiling surface

When tightening the mounting tabs, the tabs automatically turn outward, thus clamping the speaker to the wall from its rear side.



Do not over-tighten the screws. It may cause damage to both the speakers and the surface.

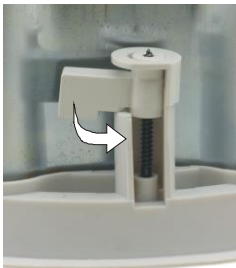

Figure 6: Tighten the Mounting Tabs

9. If required, you can further secure the speaker by connecting the speaker support ring to an independent secure anchor point.
10. Adjust each speaker to the appropriate tap setting before installing the grille (see [Figure 7](#)).

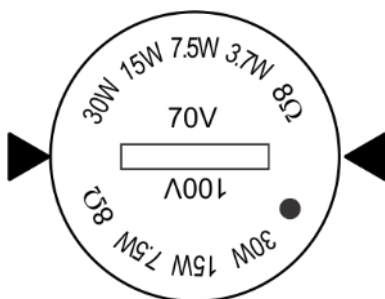

Figure 7: Adjust Tap Selector

11. Install the grilles to the speakers:

- Push the grille fastener into the hole in front of the baffle
- Press the grille into place until the front of the grille is flush with the rim of the baffle
- Check that the grille is securely seated



To remove the grille, insert two bent paper clips into the holes in the grille and carefully pull it down. Repeat this around the perimeter of the grille until it is completely removed.

## 5.4 Setting up an Array Installation

When installing **Galil 4-C** in an array installation layout, you have to define the distance between speakers as well as the layout pattern (square or hexagonal). The distance between speakers is set according to the speakers' dispersion angle, the uniformity of the coverage desired and the budget.

The coverage angle of the speaker determines the coverage area and the number of speakers required in the array installation. Two patterns are usually used for array installations, square (see [Figure 8](#)) or hexagonal (see [Figure 9](#)), depending on the shape of the installation area. The speakers are positioned according to their coverage area.

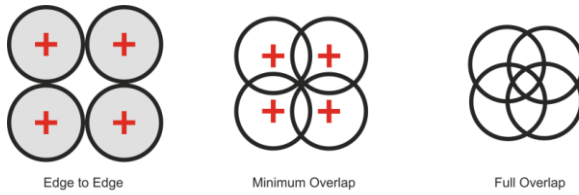

Figure 8: Square Layout

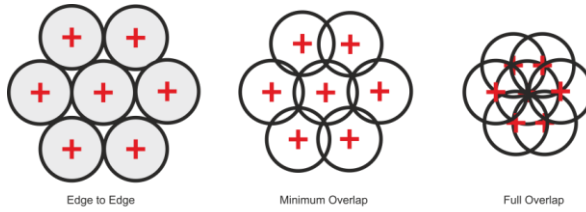

Figure 9: Hexagonal Layout

You can set the power on each speaker to get the desired power level in different installation areas.

[Figure 10](#) shows an example of parallel wiring in a square array installation:

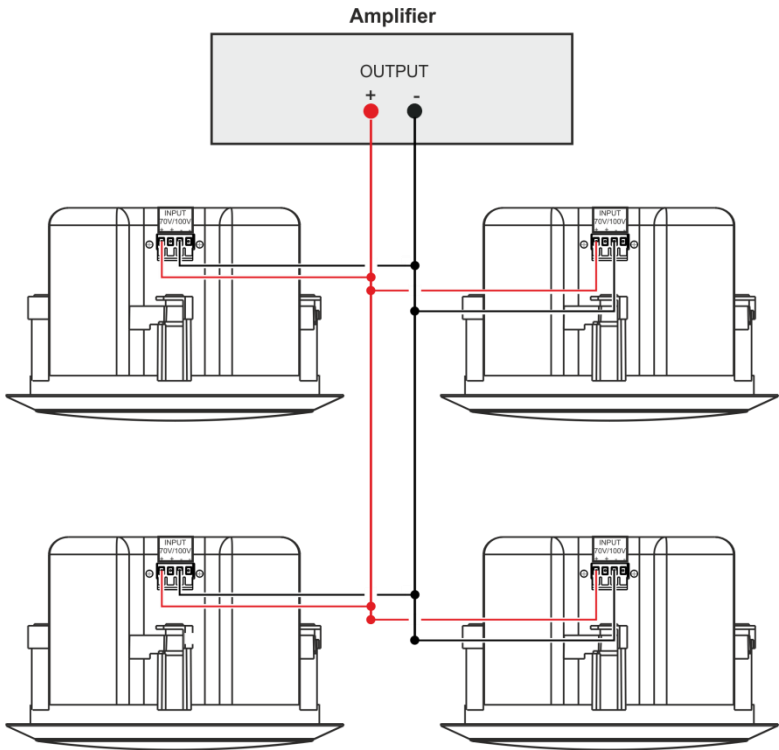

Figure 10: Square Layout Parallel Wiring



## 5.5 Painting the Speaker

You can paint the speakers before or after they are installed.

When painting before installation:

- Clean the rim and grille with mineral spirits or other light solvent that is unlikely to damage the surface
- Spray with color by holding the spray can at an angle of 45°



When spraying the grille, take care not to clog the holes in the grille as this will greatly reduce the sound quality of the speakers.

When painting after installation:

- Use the circle that you cut out of the template as a paint mask
- After you finish painting, remove the paint mask

## 6 Technical Specifications

Galil 4-C	
Audio and Power	
DESCRIPTION:	2-Way closed-back ceiling speakers
FREQUENCY RESPONSE:	85Hz to 20kHz @ -10dB 100Hz to 20kHz @ ±3dB
WOOFER:	4" (103mm) polypropylene with rubber surround
TWEETER:	0.5" (13mm) Mylar
IMPEDANCE:	8Ω (transformer tap in off position)
TRANSFORMER TAPS:	70V – 30W / 15W / 7.5W / 3.7W / Off (Lo-Z) 100V – 30W / 15W / 7.5W / Off (Lo-Z)
SENSITIVITY:	85dB SPL, 1W@1m
MAX SPL:	Continuous: 95dB Peak: 97dB
POWER HANDLING:	30W RMS 80W continuous program
CROSSOVER FREQUENCY:	6kHz
DIRECTIVITY FACTOR (Q):	4.2, averaged 1kHz to 10kHz
DIRECTIVITY INDEX (DI):	6.2dB averaged 1kHz to 10kHz
INPUT CONNECTOR:	Terminal block
Shipping and Installation	
MATERIALS:	ABS bezel, aluminum grill, metal back can
OPERATING TEMPERATURE:	0° to +40°C (32° to 104°F)
STORAGE TEMPERATURE:	-40° to +70°C (-40° to 158°F)
HUMIDITY:	10% to 90%, RHL non-condensing
WEIGHT PER SINGLE SPEAKER:	1.75kg (3.9lbs) approx.
SHIPPING WEIGHT (FOR PAIR):	6.1kg (13.5lbs) approx.
DIMENSIONS:	External diameter: 19.5cm (7.68"); cutout diameter: 16.7cm (6.57")
INSTALLATION CLEARANCE:	Mounting depth: 10.7cm (4.2")
ACCESSORIES:	Installation bracket, safety cord attached to grill, ceiling mounting kit, cutout template
COLORS:	White
Specifications are within a 10% tolerance and are subject to change without notice at <a href="http://www.kramerelectronics.com">http://www.kramerelectronics.com</a>	

## LIMITED WARRANTY

The warranty obligations of Kramer Electronics for this product are limited to the terms set forth below:

### What is Covered

This limited warranty covers defects in materials and workmanship in this product.

### What is Not Covered

This limited warranty does not cover any damage, deterioration or malfunction resulting from any alteration, modification, improper or unreasonable use or maintenance, misuse, abuse, accident, neglect, exposure to excess moisture, fire, improper packing and shipping (such claims must be presented to the carrier), lightning, power surges, or other acts of nature. This limited warranty does not cover any damage, deterioration or malfunction resulting from the installation or removal of this product from any installation, any unauthorized tampering with this product, any repairs attempted by anyone unauthorized by Kramer Electronics to make such repairs, or any other cause which does not relate directly to a defect in materials and/or workmanship of this product. This limited warranty does not cover cartons, equipment enclosures, cables or accessories used in conjunction with this product.

Without limiting any other exclusion herein, Kramer Electronics does not warrant that the product covered hereby, including, without limitation, the technology and/or integrated circuit(s) included in the product, will not become obsolete or that such items are or will remain compatible with any other product or technology with which the product may be used.

### How Long Does this Coverage Last

One year as of this printing; please check our Web site for the most current and accurate warranty information.

### Who is Covered

Only the original purchaser of this product is covered under this limited warranty. This limited warranty is not transferable to subsequent purchasers or owners of this product.

### What Kramer Electronics will do

Kramer Electronics will, at its sole option, provide one of the following three remedies to whatever extent it shall deem necessary to satisfy a proper claim under this limited warranty:

1. Elect to repair or facilitate the repair of any defective parts within a reasonable period of time, free of any charge for the necessary parts and labor to complete the repair and restore this product to its proper operating condition. Kramer Electronics will also pay the shipping costs necessary to return this product once the repair is complete.
2. Replace this product with a direct replacement or with a similar product deemed by Kramer Electronics to perform substantially the same function as the original product.
3. Issue a refund of the original purchase price less depreciation to be determined based on the age of the product at the time remedy is sought under this limited warranty.

### What Kramer Electronics will not do Under This Limited Warranty

If this product is returned to Kramer Electronics or the authorized dealer from which it was purchased or any other party authorized to repair Kramer Electronics products, this product must be insured during shipment, with the insurance and shipping charges prepaid by you. If this product is returned uninsured, you assume all risks of loss or damage during shipment. Kramer Electronics will not be responsible for any costs related to the removal or re-installation of this product from or into any installation. Kramer Electronics will not be responsible for any costs related to any setting up this product, any adjustment of user controls or any programming required for a specific installation of this product.

### How to Obtain a Remedy under this Limited Warranty

To obtain a remedy under this limited warranty, you must contact either the authorized Kramer Electronics reseller from whom you purchased this product or the Kramer Electronics office nearest you. For a list of authorized Kramer Electronics resellers and/or Kramer Electronics authorized service providers, please visit our web site at [www.kramerelectronics.com](http://www.kramerelectronics.com) or contact the Kramer Electronics office nearest you.

In order to pursue any remedy under this limited warranty, you must possess an original, dated receipt as proof of purchase from an authorized Kramer Electronics reseller. If this product is returned under this limited warranty, a return authorization number, obtained from Kramer Electronics, will be required. You may also be directed to an authorized reseller or a person authorized by Kramer Electronics to repair the product.

If it is decided that this product should be returned directly to Kramer Electronics, this product should be properly packed, preferably in the original carton, for shipping. Cartons not bearing a return authorization number will be refused.

### Limitation on Liability

THE MAXIMUM LIABILITY OF KRAMER ELECTRONICS UNDER THIS LIMITED WARRANTY SHALL NOT EXCEED THE ACTUAL PURCHASE PRICE PAID FOR THE PRODUCT. TO THE MAXIMUM EXTENT PERMITTED BY LAW, KRAMER ELECTRONICS IS NOT RESPONSIBLE FOR DIRECT, SPECIAL, INCIDENTAL OR CONSEQUENTIAL DAMAGES RESULTING FROM ANY BREACH OF WARRANTY OR CONDITION, OR UNDER ANY OTHER LEGAL THEORY. Some countries, districts or states do not allow the exclusion or limitation of relief, special, incidental, consequential or indirect damages, or the limitation of liability to specified amounts, so the above limitations or exclusions may not apply to you.

### Exclusive Remedy

TO THE MAXIMUM EXTENT PERMITTED BY LAW, THIS LIMITED WARRANTY AND THE REMEDIES SET FORTH ABOVE ARE EXCLUSIVE AND IN LIEU OF ALL OTHER WARRANTIES, REMEDIES AND CONDITIONS, WHETHER ORAL OR WRITTEN, EXPRESS OR IMPLIED. TO THE MAXIMUM EXTENT PERMITTED BY LAW, KRAMER ELECTRONICS SPECIFICALLY DISCLAIMS ANY AND ALL IMPLIED WARRANTIES, INCLUDING, WITHOUT LIMITATION, WARRANTIES OF MERCHANTABILITY AND FITNESS FOR A PARTICULAR PURPOSE. IF KRAMER ELECTRONICS CANNOT LAWFULLY DISCLAIM OR EXCLUDE IMPLIED WARRANTIES UNDER APPLICABLE LAW, THEN ALL IMPLIED WARRANTIES COVERING THIS PRODUCT, INCLUDING WARRANTIES OF MERCHANTABILITY AND FITNESS FOR A PARTICULAR PURPOSE, SHALL APPLY TO THIS PRODUCT AS PROVIDED UNDER APPLICABLE LAW.

IF ANY PRODUCT TO WHICH THIS LIMITED WARRANTY APPLIES IS A "CONSUMER PRODUCT" UNDER THE MAGNUSON-MOSS WARRANTY ACT (15 U.S.C.A. §2301, ET SEQ.) OR OTHER APPLICABLE LAW, THE FOREGOING DISCLAIMER OF IMPLIED WARRANTIES SHALL NOT APPLY TO YOU, AND ALL IMPLIED WARRANTIES ON THIS PRODUCT, INCLUDING WARRANTIES OF MERCHANTABILITY AND FITNESS FOR THE PARTICULAR PURPOSE, SHALL APPLY AS PROVIDED UNDER APPLICABLE LAW.

### Other Conditions

This limited warranty gives you specific legal rights, and you may have other rights which vary from country to country or state to state.

This limited warranty is void if (i) the label bearing the serial number of this product has been removed or defaced, (ii) the product is not distributed by Kramer Electronics or (iii) this product is not purchased from an authorized Kramer Electronics reseller. If you are unsure whether a reseller is an authorized Kramer Electronics reseller, please visit our Web site at [www.kramerelectronics.com](http://www.kramerelectronics.com) or contact a Kramer Electronics office from the list at the end of this document.

Your rights under this limited warranty are not diminished if you do not complete and return the product registration form or complete and submit the online product registration form. Kramer Electronics thanks you for purchasing a Kramer Electronics product. We hope it will give you years of satisfaction.



For the latest information on our products and a list of Kramer distributors, visit our Web site where updates to this user manual may be found.

**We welcome your questions, comments, and feedback.**

Web site: [www.kramerelectronics.com](http://www.kramerelectronics.com)

E-mail: [info@kramerel.com](mailto:info@kramerel.com)



### SAFETY WARNING

Disconnect the unit from the power supply before opening and servicing



P/N:

2900-300344



Rev:

2