



iMatrix H44VAW

4K60 4x4 Seamless Matrix, w/ videowall &
multiviewer



User Manual

VER 1.0

www.infobitav.com info@infobitav.com

Thank you for purchasing this product

For optimum performance and safety, please read these instructions carefully before connecting, operating or adjusting this product. Please keep this manual for future reference.

Surge protection device recommended

This product contains sensitive electrical components that may be damaged by electrical spikes, surges, electric shock, lightning strikes, etc. Use of surge protection systems is highly recommended in order to protect and extend the life of your equipment.

Caution

The product requires the use of UTP connectors. Please connect in direct interconnection method and do not cross connect.

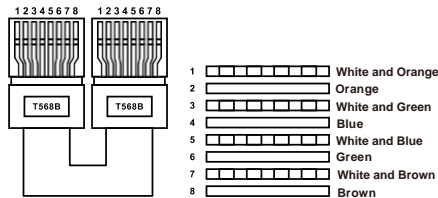

Direct Interconnection Method

Table of Contents

1. Introduction.....	1
2. Features.....	1
3. Package Contents.....	1
4. Specifications.....	2
5. Operation Controls and Functions.....	3
6. IR Remote.....	7
7. IR Cable Pin Assignment.....	8
8. IR Control System.....	9
9. Video Wall.....	9
10. Multi-Viewer.....	10
11. EDID Management.....	11
12. Web GUI User Guide.....	13
13. RS-232 Control Command.....	25
14. Application Example.....	38

1. Introduction

The 4K60 4x4 Seamless Matrix is a perfect solution for video transmission from 4 HDMI sources to 4 HDTV displays. It has video wall and multi-viewer functions with multiple display modes. 4x4 IR matrix, audio embedded and de-embedded are also supported. Video resolution is up to 4K@60Hz 4:4:4. Each of the sources can be individually scaled. And seamless switching ensures a smooth picture transition without frame loss.

This matrix can be controlled via front panel buttons, LCD screen, IR remote, RS-232, and Web GUI.

2. Features

- ☆ HDMI 2.0 and HDCP 2.2 compliant
- ☆ Video resolution is up to 4K@60Hz 4:4:4
- ☆ Support 18Gbps video bandwidth
- ☆ Support 12 display categories in multi-viewer mode, and 9 splicing modes in video wall mode
- ☆ HDMI audio format: LPCM, Dolby Digital/Plus/EX, Dolby True HD, DTS, DTS-EX, DTS-96/24, DTS High Res, DTS-HD Master Audio
- ☆ Support CEC control, and multiple video resolution output
- ☆ Advanced EDID management
- ☆ Control via front panel buttons, IR remote, RS-232, and Web GUI

3. Package Contents

- ① 1 × 4K60 4x4 Seamless Matrix
- ② 1 × 12V/2.5A Locking Power Adapter
- ③ 5 × 12V IR Wideband Receiver Cable (1.5m)
- ④ 4 × IR Blaster Cable (1.5m)
- ⑤ 1 × RS-232 Serial Cable (1.5m, male to female head)
- ⑥ 4 × 5pin-3.81mm Phoenix Connector
- ⑦ 4 × 3pin-3.81mm Phoenix Connector
- ⑧ 8 × Machine Screw (KM3*6)
- ⑨ 2 × Mounting Ear
- ⑩ 1 × User Manual

4. Specifications

Technical			
HDMI Compliance	HDMI 2.0		
HDCP Compliance	HDCP 2.2		
Video Bandwidth	594MHz/18Gbps		
Video Resolution	480i ~1080P@50/60Hz, 4K2K@24/30Hz, 4K2K@60Hz		
Color Space	RGB, YCbCr 4:4:4, YCbCr 4:2:2, YCbCr 4:2:0		
Color Depth	8/10/12-bit		
Audio Formats	LPCM, Dolby Digital/Plus/EX, Dolby True HD, DTS, DTS-EX, DTS-96/24, DTS High Res, DTS-HD Master Audio		
IR Level	12Vp-p		
IR Frequency	Wideband 20K-60KHz		
ESD Protection	Human body model — ±8kV (Air-gap discharge) & ±4kV (Contact discharge)		
Connection			
Input ports	4 × HDMI INPUT [Type A, 19-pin female] 4 × L/R AUDIO INPUT [3.81mm, 3pin Phoenix Connector]		
Output ports	4 × HDMI OUTPUT [Type A, 19-pin female] 4 × OPTICAL AUDIO OUT [S/PDIF] 4 × L/R AUDIO OUT [3.81mm, 5pin Phoenix Connector]		
Control ports	1 × TCP/IP [RJ45] 1 × RS-232 [D-Sub 9] 1 × IR EXT [3.5mm, Stereo Mini-jack] 4 × IR INPUT [3.5mm, Stereo Mini-jack] 4 × IR OUTPUT [3.5mm, Stereo Mini-jack]		
Mechanical			
Housing	Metal Enclosure		
Color	Black		
Dimensions	440mm [W] × 203mm [D] × 44.5mm [H]		
Weight	2.55kg		
Power Supply	Input: AC 100-240V 50/60Hz, Output: DC 12V/2.5A (US/EU standard, CE/FCC/UL certified)		
Power Consumption	25W (Max)		
Operating Temperature	32 - 104°F / 0 - 40°C		
Storage Temperature	-4 - 140°F / -20 - 60°C		
Relative Humidity	20 - 90% RH (no-condensing)		
Video Resolution	4K60	4K30	1080P60
HDMI Cable Length (HDMI IN / OUT)	5m/16ft	10m/32ft	15m/50ft
The use of "Premium High Speed HDMI" cable is highly recommended.			

5. Operation Controls and Functions

5.1 Front Panel

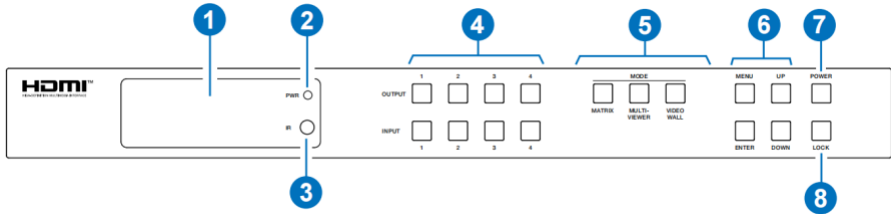

NO.	Name	Function Description
1	LCD screen	Display matrix switching status, input / output port, EDID, Baud rate, IP Address, etc.
2	PWR LED	The LED is on green when the device is working. The LED is on red when the device is on standby.
3	IR	IR signal receiver, receiving the signal from the IR remote.
4	INPUT / OUTPUT buttons	You need to press an output button (1~4) firstly and then press an input button (1~4) to select the corresponding input source for the output port.
5	MODE (MATRIX / MULTIVIEWER / VIDEO WALL)	Press these buttons to select the corresponding video mode as required. MATRIX: Press Matrix button to enter the matrix mode. You can operate via front panel buttons, RS-232 commands and Web GUI to set more details of the matrix mode. MULTIVIEWER: Press MULTIVIEWER button to enter the multi-viewer mode (The output buttons are used as Windows). You can operate via front panel buttons, RS-232 commands and Web GUI to set more details of the multi-viewer mode. VIDEO WALL: Press VIDEO WALL button to enter the video wall mode (The output buttons are used as Groups). You can operate via front panel buttons, RS-232 commands and Web GUI to set more details of the video wall mode.
6	MENU / ENTER / UP /DOWN	Take RESET, for example. ① On the initial LCD display screen, press "MENU" button. There are OUTPUT/MV/VM/INPUT/EXTAUDIO/SET items to be selected. ② Press the "UP/DOWN" button to select "SET" item. ③ Press the "ENTER" button to enter into the next level menu. There are LCD ONTIME/BAUD RATE/IP INFO/BG PATTERN/REBOOT/RESET items to be selected. ④ Press the "UP/DOWN" button to select "RESET" item. ⑤ Press the "ENTER" button to confirm the selection. ⑥ Press the "ENTER" button, and then it will prompt: SUCCESS! Note: • Pressing the "MENU" button will return to the previous menu. • In any level menu, it will return to the initial display screen if no operation goes on within 10 seconds.
7	POWER button	Long press the button for 1 second to enter the standby mode, then short press it to wake up the device.
8	LOCK button	Short press the button to lock front panel buttons (Except the power button); press it again to unlock.

5.2 Rear Panel

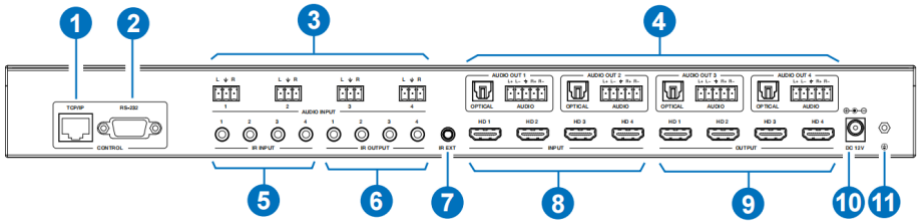

NO.	Name	Function Description
1	TCP/IP	TCP/IP control port, connected to PC or router with a CAT cable.
2	RS-232 port	Connect to a PC or control system by D-Sub 9-pin cable to transmit RS-232 command.
3	AUDIO INPUT (1~4)	L/R analog audio input port, connected to an analog audio input source such as DVD or Blu-ray Player. It follows HDMI input (1~4), and the embedded audio can not be extracted to audio out channel to output.
4	AUDIO OUT (1~4)	OPTICAL: Optical audio output port, connected to an audio output device such as audio amplifier. L/R AUDIO: Analog audio output port, supporting balanced audio output (with a maximum support of 2Vrms) and unbalanced audio output. Balanced connection method: L+, L-, $\frac{1}{2}$, R+, R- Unbalanced connection method: L+, $\frac{1}{2}$, R+
5	IR INPUT (1~4)	Connect with IR receiver cable.
6	IR OUTPUT (1~4)	Connect with IR blaster cable.
7	IR EXT	If the IR receiver window of the unit is blocked or the unit is installed in a closed area out of infrared line of sight, the IR receiver cable can be connected to the "IR EXT" port to receive the IR remote signal.
8	HDMI INPUT ports (1~4)	HDMI input ports, connected to HDMI source devices such as computer, DVD or set-top box with an HDMI cable.
9	HDMI OUTPUT ports (1~4)	HDMI output ports, connected to HDMI display devices such as TV or monitor with an HDMI cable.
10	DC 12V	Connect to 24V/2.5A power adapter.
11	GND	Connect the housing to the ground.

Note:

1. You can restore the factory settings via the front panel, Web GUI or RS-232 command.
2. Power cut memory function is available except for standby status and panel lock.
3. The RS-232 and Web will be available in a few minutes when the device is powered on.

5.3 LCD Display Navigation

The buttons on the the front panel are used for LCD display navigation, including INPUT(1~4), OUTPUT(1~4), MATRIX, MULTIVIEWER, VIDEOWALL, MENU, ENTER, UP, DOWN, POWER, LOCK.

Menu items are as follows:

Level 1	Level 2	Level 3	Level 4
OUTPUT	RESO	OUT1 / OUT2 / OUT3 / OUT4	4Kx2K60W, 4Kx2K50W, 4Kx2K60, 4Kx2K50, 4Kx2K30, 1080P60, 1080P50, 1080i60, 1080i50, WUXGA60_RB, 1360x768@60, 1280x800@60, 720P60, 720P50, XGA60, AUTO
	CSC	OUT1 / OUT2 / OUT3 / OUT4	RGB 444 YUV 444 YUV 422 YUV 420
	STREAM	OUT1 / OUT2 / OUT3 / OUT4	ENABLE DISABLE
	H MIRROR	OUT1 / OUT2 / OUT3 / OUT4	ENABLE DISABLE
	V MIRROR	OUT1 / OUT2 / OUT3 / OUT4	ENABLE DISABLE
MV	MODE	SINGLE / PIP / DUAL / TRIPLE-1 / TRIPLE-2 / TRIPLE-3 / QUAD-1 / QUAD-2 / QUAD-3 / USER-1 / USER-2 / USER-3	
	ASPECT	FULL / 16:9	
	PIP POSITION	UPPER LEFT LOWER LEFT UPPER RIGHT LOWER RIGHT	
	PIP SIZE	SMALL / MIDDLE / LARGE	

Level 1	Level 2	Level 3	Level 4
VW	MODE	2×2 / 2×1 / 2×2-2 / 1×2 / 1×2-2 / 3×1 / 4×1 / 1×3 / 1×4	
	RESO	4K2K60W / 4K2K50W / 4K2K60 / 4K2K50 / 4K2K30 / 1080P60 / 1080P50 / 1080i60 / 1080i50 / WUXGA60_RB / 1360x768@60 / 1280x800@60 / 720P60 / 720P50 / XGA60	
	H BEZEL	0-10	
	V BEZEL	0-10	
INPUT	EDID	IN1 / IN2 / IN3 / IN4	4K60, 2.0CH 4K60, 5.1CH 4K60, 7.1CH 4K30, 2.0CH 4K30, 5.1CH 4K30, 7.1CH 1080P, 2.0CH 1080P, 5.1CH 1080P, 7.1CH WUXGA, 2.0CH 768P, 2.0CH XGA, 2.0CH USER1 USER2 COPY OUT1 COPY OUT2 COPY OUT3 COPY OUT4
	AUDIOSEL	IN1 / IN2 / IN3 / IN4	ORIGINAL EMBED
EXTAUDIO	OUT	OUT1 / OUT2 / OUT3 / OUT4	ENABLE DISABLE
	MODE	BIND TO INPUT / BIND TO OUTPUT / AUDIO MATRIX	
	MATRIX	OUT1 / OUT2 / OUT3 / OUT4	INPUT1 INPUT2 INPUT3 INPUT4
SET	LCD ONTIME	OFF / ALWAYS ON / 15 SECONDS / 30 SECONDS / 60 SECONDS	
	BAUD RATE	4800 / 9600 / 19200 / 38400 / 57600 / 115200	
	IP INFO	DHCP:ON / OFF	
	BG PATTERN	BLACK SCREEN / BLUE SCREEN / COLOR BAR / GRAY SCALE / CROSS / CROSS HATCH	
	REBOOT	Y / N	
	RESET	Y / N	

6. IR Remote



Power on or Standby:

Power on the Matrix or set it to standby mode.

INFO:

Press to check the serial baud rate and IP address. It will be displayed in the top right corner of the screen, and disappear in five seconds or press the button again.

INPUT 1/2/3/4:

Press these buttons to select input sources.



Select the last or next input source.

OUTPUT 1/2/3/4:

Select the output display device.

ALL:

Select all output simultaneously. For example, when you press the “ALL” button and then press input “1” button, at this time the input “1” source will be output to all display devices.

VIDEO MODE:

There are three video output modes: MATRIX, VIDEO WALL and MULTI-VIEWER. It will memorize the correspondence between the inputs and outputs and the configuration which are set in each mode on Web page last time when you switch the modes.

Operation Instruction:

You need to press the output button firstly and then press input button to select the corresponding input source. For example, press Output-X (X means output button from 1 to 4 , including “ALL” button), then press Input-Y (Y means input button from 1 to 4)

The Matrix can be selected input and output source by using the IR remote. There are two ways to receive the IR remote signal.

The first way: The IR window accepts the IR remote signal. Using the IR remote, the furthest distance is 8 meters when the IR remote is directly faced to the matrix, and 5 meters when the using angle is $\pm 45^\circ$. The diagram is shown as below:

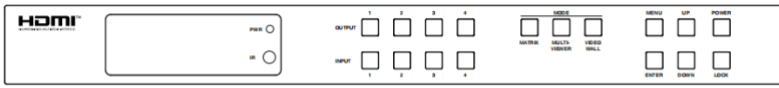

IR remote of the Matrix

The second way: If the IR receiver window of the Matrix is blocked or the Matrix is installed in a closed area out of infrared line of sight, the IR receiver cable can be inserted to the "IR EXT" port to receive the IR remote signal. The furthest distance of using the IR remote is 5 meters when the IR remote is directly faced to the IR receiver head, and 3 meters when the using angle is $\pm 45^\circ$. The diagram is shown as below.

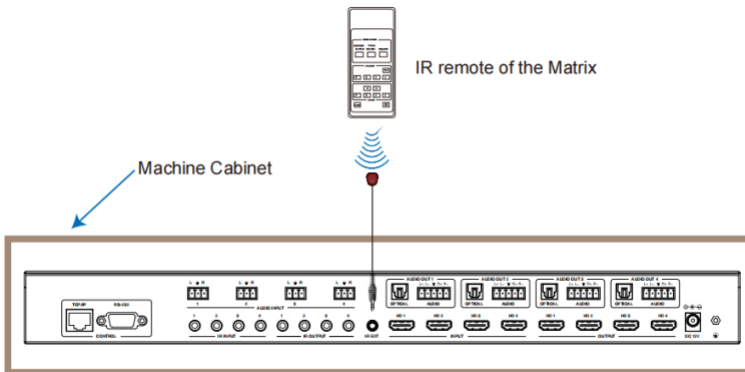

7. IR Cable Pin Assignment



IR BLASTER

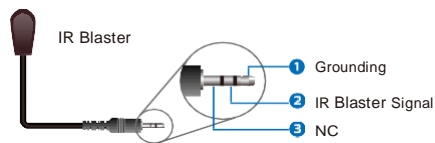

IR RECEIVER

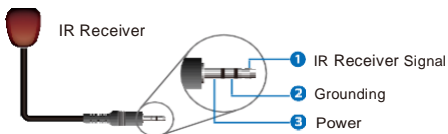

8. IR Control System

This product supports one-way IR control. When the matrix is connected to IR receiver cable and IR blaster cable, you can control the corresponding input source devices through IR signal transmission remotely at the side of display devices.

Four IR blaster cables connected to the IR outputs must be placed near the four HDMI input sources. Four IR receiver cables connected to the IR inputs must be placed near the display devices connected to the four HDMI outputs.

IR matrix follows the HDMI matrix. For example, if HDMI INPUT3 is selected for HDMI OUT1 to output, the signal of IR OUT3 near the HDMI INPUT3 is emitted to IR IN1 near the HDMI OUT1. Now you can use the IR remote of the DVD connected to HDMI INPUT3 to control it at the side of the TV connected to HDMI OUT1.

Similarly, if HDMI INPUT1 is selected for all HDMI OUT1/2/3/4 to output, the signal of IR OUT1 near the HDMI INPUT1 is emitted to IR IN1/2/3/4 near the four HDMI OUTs.

9. Video Wall

The matrix supports 10 categories of display modes as below:

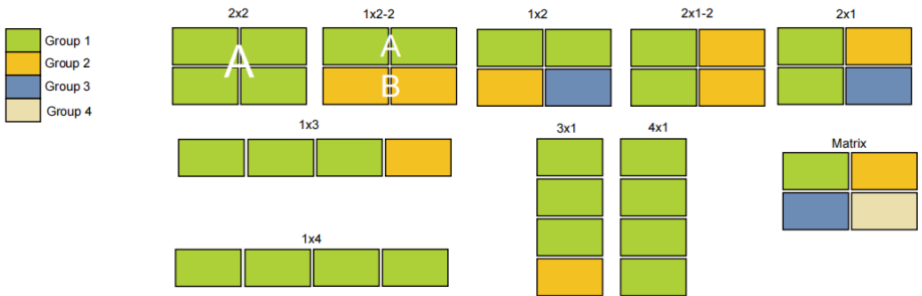

User can select display modes via front panel buttons, Web GUI, and RS-232 commands.

10. Multi-Viewer

The matrix supports multiple display modes:

SINGLE, PIP, Dual, Triple 1, Triple 2, Triple 3, Quad 1, Quad 2, Quad 3, User 1, User 2, User 3.

Users can select different operations for different multi-viewer modes as following:

SINGLE: Inputs selection

PIP: Inputs selection, Sub window size and position selection

Dual, Triple 1, Triple 2, Triple 3, Quad 1, Quad 2, Quad 3: Inputs selection, Display mode selection, Display aspect selection

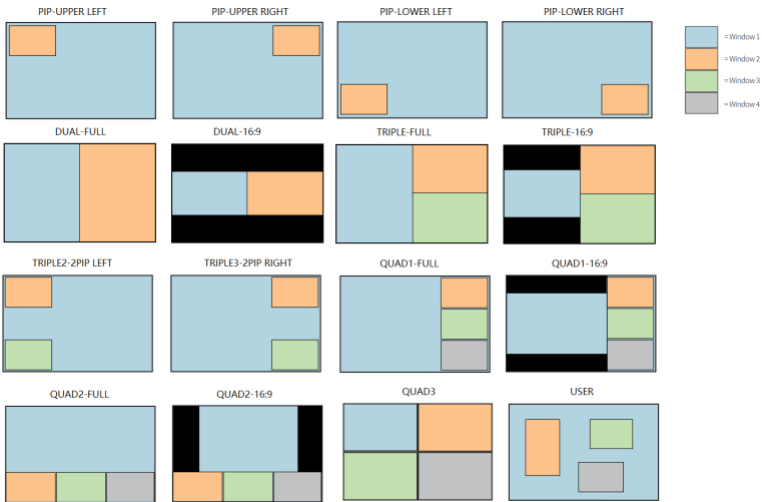

11. EDID Management

This Matrix has 12 factory defined EDID settings, 2 user-defined EDID modes and 4 copy EDID modes. You can select defined EDID mode or copy EDID mode to input port through front panel buttons, RS-232 control or Web GUI.

On-panel button operation: On the initial LCD display screen, press “MENU” button to enter the first level menu, press “UP/DOWN” button to select INPUT, and then press the “ENTER” button. Now the EDID item appears. Press the “ENTER” button, and then press “UP/DOWN” button to select the EDID mode you need. Then press “ENTER” button to confirm this operation.

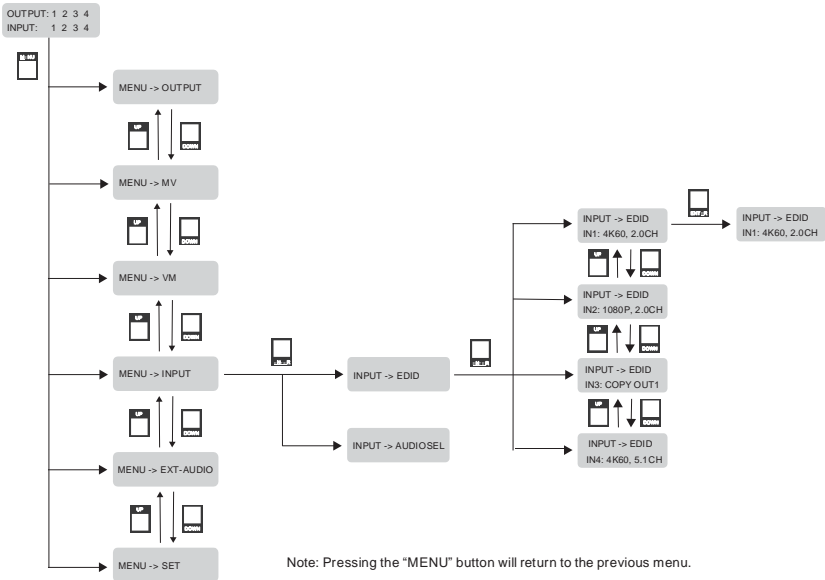

RS-232 control operation: Connect the Matrix to PC with a serial cable, then open a Serial Command tool on PC to send ASCII command “s input x EDID z!” to set EDID. For details, please refer to “EDID Setting” in the ASCII command list of “13. RS-232 Control Command”.

Web GUI Operation: Please check the EDID management in the “Input page” of “12. Web GUI User Guide”.

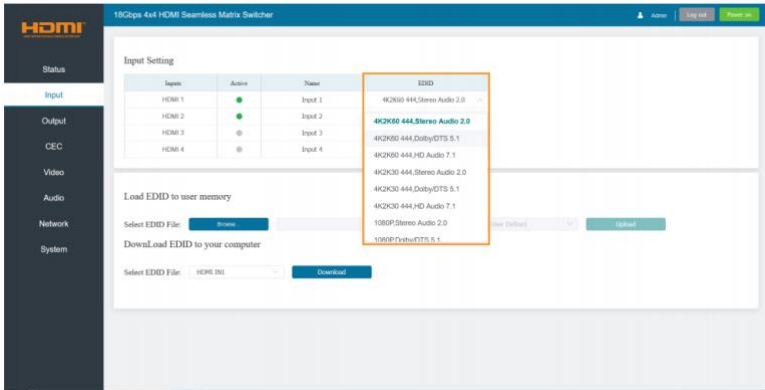

The defined EDID setting list of the product is shown as below:

EDID Mode	EDID Description
1	4K60, 2.0CH
2	4K60, 5.1CH
3	4K60, 7.1CH
4	4K30, 2.0CH
5	4K30, 5.1CH
6	4K30, 7.1CH
7	1080P, 2.0CH
8	1080P, 5.1CH
9	1080P, 7.1CH
10	WUXGA, 2.0CH
11	768P, 2.0CH
12	XGA, 2.0CH
13	USER1
14	USER2
15	COPY OUT1
16	COPY OUT2
17	COPY OUT3
18	COPY OUT4

12. Web GUI User Guide

The Matrix can be controlled by Web GUI. The operation method is shown as below:

Step 1: Get the current IP Address.

The default IP address is 192.168.0.100. You can get the current Matrix IP address in two ways:

The first way: You can get the IP address via IR remote. Pressing the INFO button on the IR remote, the IP address and serial baud will be displayed in the top right corner of the screen.

The second way: You can get the IP address via RS-232 control. Send the command “r ip addr!” through an ASCII Command tool, and then you’ll get the feedback information as shown below:

IP: 192.168.0.100

IP:192.168.0.100 in the above figure is the IP Address of the Matrix (the IP address is variable, depending on what the specific machine returns).

For the details of ASCII control, please refer to “13. RS-232 Control Command”.

Step 2: Connect the TCP/IP port of the Matrix to a PC with an UTP cable, and set the IP address of the PC to be in the same network segment with the Matrix.

Step 3: Input the IP address of the Matrix into your browser on the PC to enter Web GUI page.



After entering the Web GUI page, there will be a Login page, as shown below:



Select the Username and enter the password. The default password is:

Username **User / Admin**

Password **user / admin**

Click the Language drop-down list to select English or Simplified Chinese. Then click the“LOGIN” button and the following Status page will appear.

■ Status Page

The Status page provides basic information about the Model, the installed firmware version and the network settings of the device.

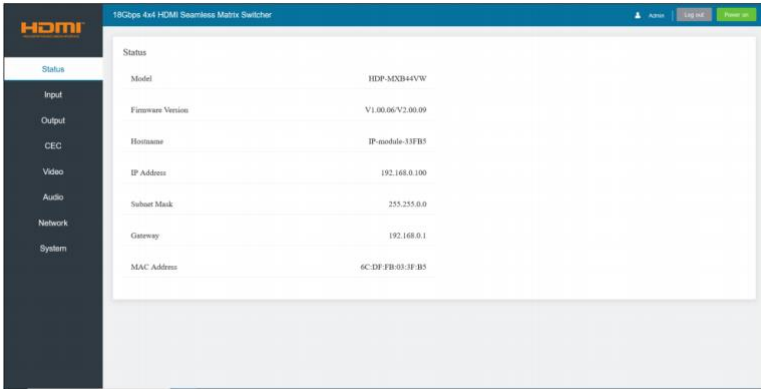

■ Input Page

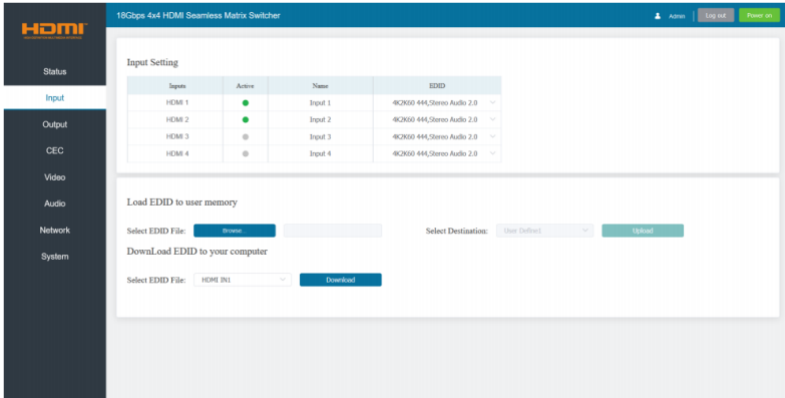

You can do the following operations on the Input page:

- ① **Input:** Input channel of the device.
- ② **Active:** It indicates whether the channel is connected to a signal source. It is green if connected, and gray if not connected.
- ③ **Name:** The input channel’s name. You can modify it by entering the corresponding name (max length: 31 characters) in the input box.

④ **EDID:** It indicates the current EDID of the device. You can click the drop-down menu to select other EDIDs.

⑤ **Load EDID to user memory:** Set EDID for the User. Click the “Browse” button, then select the bin file. If you select the wrong EDID file, there will be a prompt, as shown in the following figure:

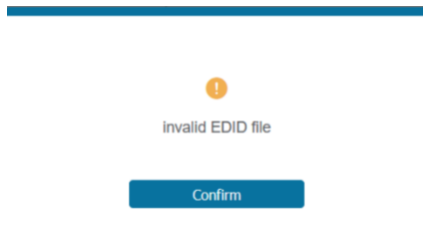

Make sure to select the correct file, then you can check the name of the selected file. Then select destination “User Define1/User Define2”, and click “Upload”.

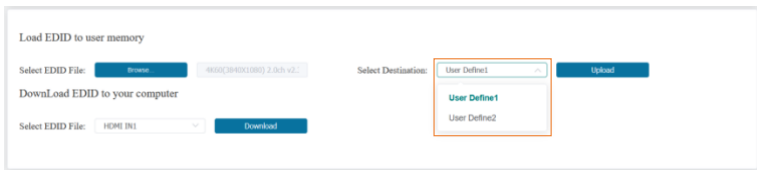

After successful setting, it will prompt as follows:

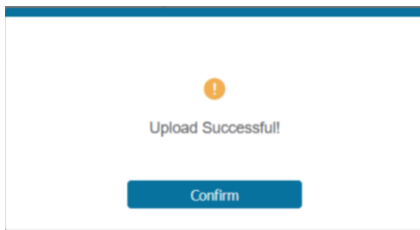

⑥ **Download EDID to your computer:**

If you want to download the existing EDID, click the drop-down box of “Select EDID File” to select the input channel you want, and then click “Download” to save the corresponding EDID file to your computer.



■ Output Page

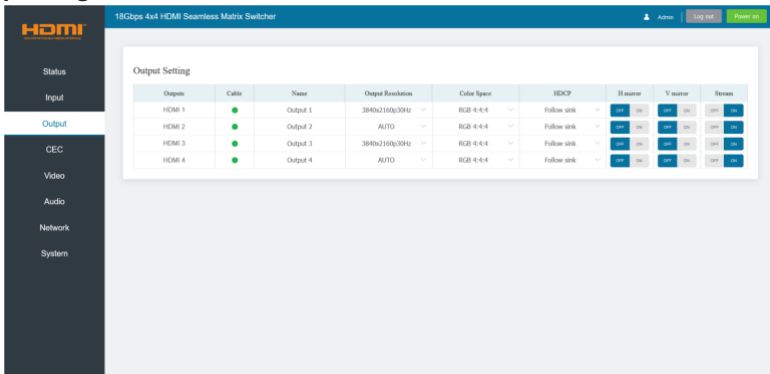

You can do the following operations on the Output page:

- ① **Outputs:** Output channel of the device.
- ② **Cable:** It indicates the connection status of output ports. When the output port is connected to the display, it shows green. Otherwise, it shows gray.
- ③ **Name:** The output channel's name. You can modify it by entering the corresponding name (max length: 31 characters) in the input box.
- ④ **Output Resolution:** Set the video resolution for current output. Click the drop-down menu and set the resolution you need. There are 16 options to be selected. If you select AUTO, it will output the proper video resolution according to the EDID of the display device.

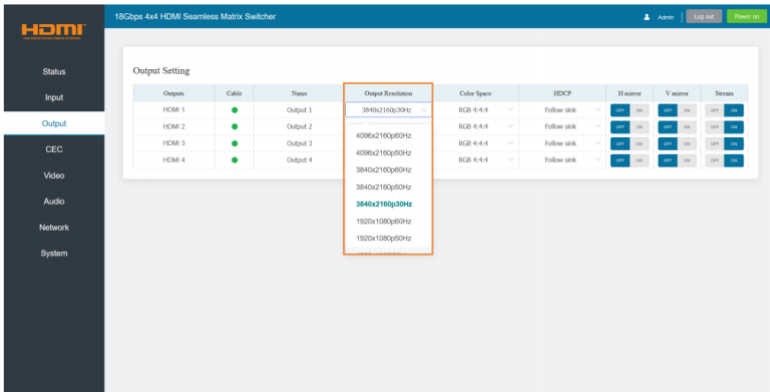

Note: Output resolution option is not available in video wall and multi-viewer mode.

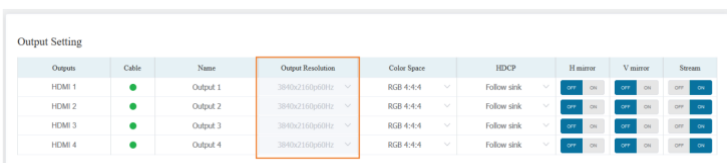

⑤ **Color Space:** Set the color space for current output. Click the drop-down menu and select the item as required. There are four options to be selected.

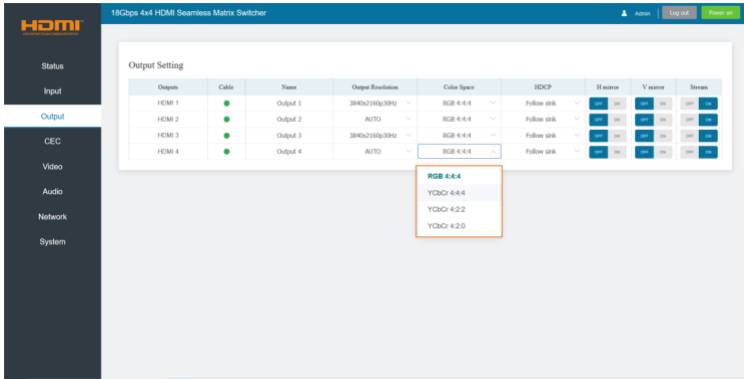

⑥ **HDCP:** Click the drop-down menu and set the HDCP version for current output.

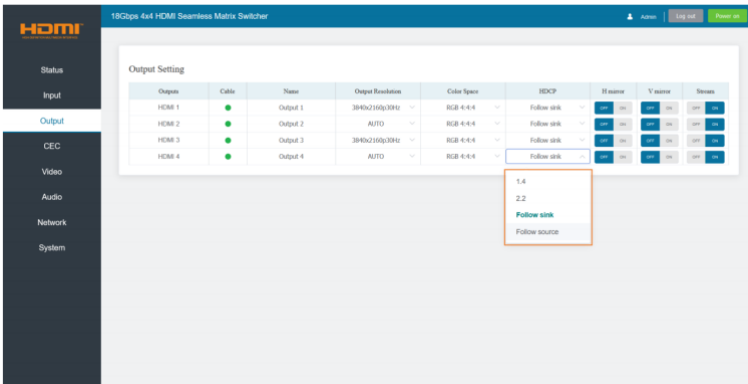

There are four options to be selected:

- 1.4: HDCP 1.4 compliant.
- 2.2: HDCP 2.2 compliant.
- Follow Sink: HDCP version follows the corresponding display device.
- Follow Source: HDCP version follows the assigned input source.

⑦ **H mirror:** Turn on/off the horizontal mirroring of the output signal.

⑧ **V mirror:** Turn on/off the vertical mirroring of the output signal.

⑨ **Stream:** Turn on/off the output stream.

■ CEC Page

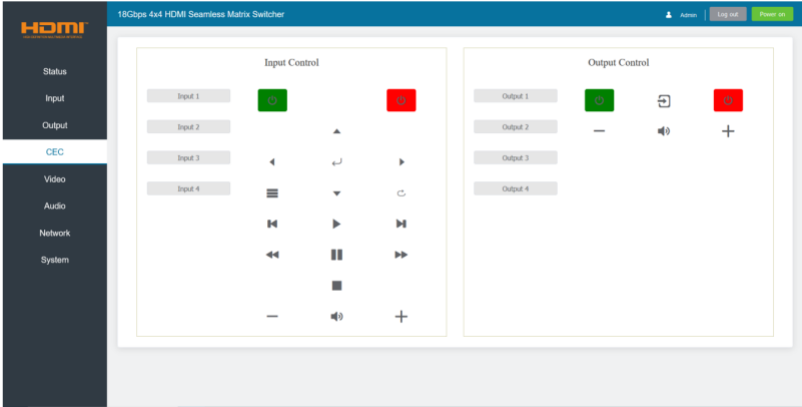

You can perform CEC management on this page. Inputs and Outputs can be controlled by clicking on the corresponding icons.

① **Input Control:** Select the input source on the left, and then click on the icons to power on, power off, return, switch, pause, fast-forward, fast-back, mute, unmute, etc.



② **Output Control:** Select the output on the left, and then click on the icons to control the operation of the display, such as power on/off, volume +/-, etc.

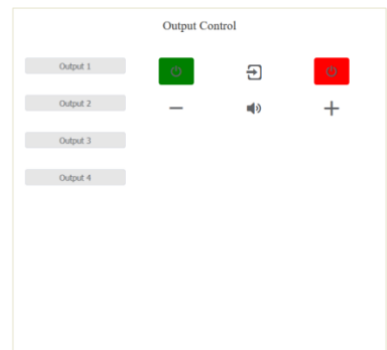

■ Video Page

You can set the video mode on this page. There are three modes: Matrix, Video Wall and Multi-Viewer.

① **Matrix:** Click to select Matrix mode.

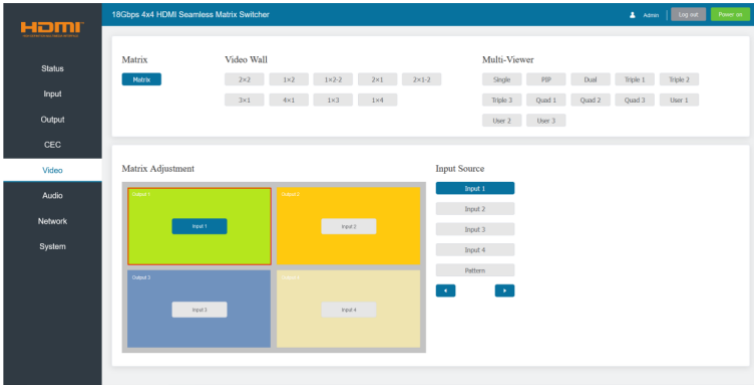

In matrix mode, you can select an output (1~4) firstly, and then select an input source (1~4) which will appear on the selected output area. One route of video output configuration is completed.

Note: You can drag and drop any input source on the right to the corresponding output easily and quickly.

② **Video Wall:** Click the buttons to select a splicing screen mode. There are 9 modes to be selected.

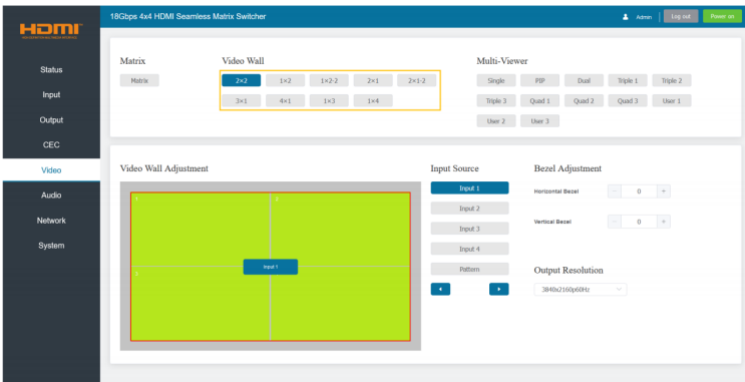

In video wall mode, you can select a window (1~4) firstly, and then select an input source (1~4) which will appear on the selected output area. Click +/- to adjust the corresponding Horizontal/Vertical Bezel (0-10). Set the output resolution for current output by clicking the drop-down list.

Note: You can drag and drop any input source on the right to the corresponding window easily and quickly.

③ **Multi-Viewer:** Click the buttons to select the multi-viewer display mode. There are 12 modes to be selected.

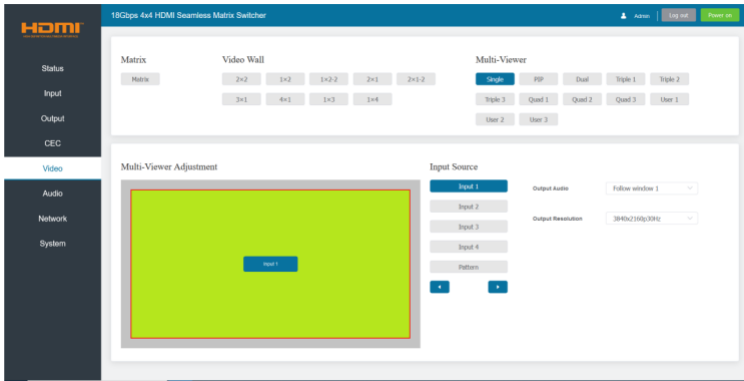

In multi-viewer mode, all the four HDMI outputs display the same image from the HDMI IN you selected. You can select the input source which will appear on the corresponding window area. Then set the output resolution for current output by clicking the drop-down list. Output Audio can be selected to follow any input source or the corresponding window as required.

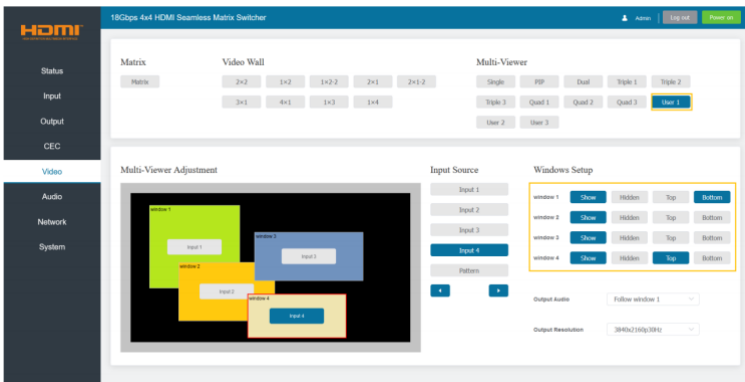

If a user-defined mode is selected, you can do the following operations on this page:

- The four windows are all displayed by default.
- Each window can be dragged and zoomed at will.
- Drag and drop the input source to any window.
- Click Windows Setup buttons to set the display of the corresponding window.
- The window will be maximized and placed on the top with double-clicking. It will restore the previous status with double-clicking again.

■ Audio Page

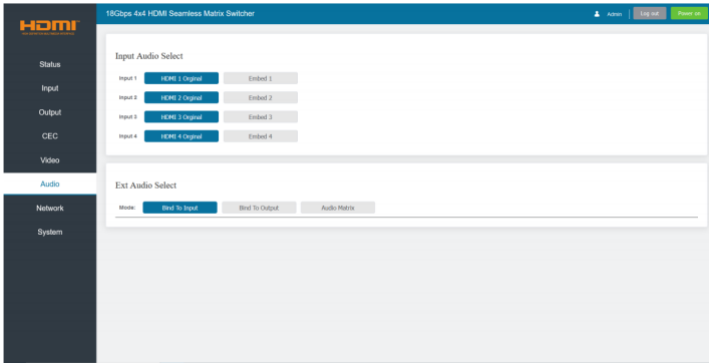

In Audio page, you can select the input audio in Input Audio Select area, and set the ext-audio mode in Ext Audio Select area.

You can select any input audio source from an HDMI input internal audio or an embedded audio. For example, if "HDMI 1Original" is selected, the audio source is from the internal audio of HDMI Input 1; if "Embed 1" is selected, the audio source is from the Embed 1 audio. (The embed audio follows HDMI INPUT, and it will be embedded in HDMI INPUT to output.)

Input Audio Select

Input 1	<input checked="" type="radio"/> HDMI 1 Original	<input type="radio"/> Embed 1
Input 2	<input checked="" type="radio"/> HDMI 2 Original	<input type="radio"/> Embed 2
Input 3	<input checked="" type="radio"/> HDMI 3 Original	<input type="radio"/> Embed 3
Input 4	<input checked="" type="radio"/> HDMI 4 Original	<input type="radio"/> Embed 4

The ext-audio has three modes: Bind to Input, Bind to Output and Audio Matrix.

Note: The embedded audio can not be extracted to audio out channel to output.

Bind to Input: The AUDIO OUT (1~4) follows the HDMI INPUT (1~4). And there is a consistent one-to-one match between each HDMI input and audio output.

For example, the audio of AUDIO OUT 1 is from HDMI INPUT 1. The audio of AUDIO OUT 2 is from HDMI INPUT 2. The audio of AUDIO OUT 3 is from HDMI INPUT 3. The audio of AUDIO OUT 4 is from HDMI INPUT 4.

Input Audio Select

Input 1	<input checked="" type="radio"/> HDMI 1 Original	<input type="radio"/> Embed 1
Input 2	<input checked="" type="radio"/> HDMI 2 Original	<input type="radio"/> Embed 2
Input 3	<input checked="" type="radio"/> HDMI 3 Original	<input type="radio"/> Embed 3
Input 4	<input checked="" type="radio"/> HDMI 4 Original	<input type="radio"/> Embed 4

Ext Audio Select

Mode: Bind To Input Bind To Output Audio Matrix

Bind to Output: The AUDIO OUT (1~4) follows the HDMI OUTPUT (1~4). For example, if HDMI INPUT 2 is assigned to HDMI OUTPUT 1, the audio of AUDIO OUT 1 is from HDMI INPUT 2; if HDMI INPUT 3 is assigned to HDMI OUTPUT 1, the audio of AUDIO OUT 1 is from HDMI INPUT 3.

Input Audio Select

Input 1	HDMI 1 Original	Embed 1
Input 2	HDMI 2 Original	Embed 2
Input 3	HDMI 3 Original	Embed 3
Input 4	HDMI 4 Original	Embed 4

Ext Audio Select

Mode: Bind To Input Bind To Output Audio Matrix

Audio Matrix: you can select the audio of any HDMI input source for the corresponding ext-audio out.

Ext Audio Select

Mode: Bind To Input Bind To Output Audio Matrix

Audio Matrix

Ext-Audio Out 1	Input 1	Input 2	Input 3	Input 4
Ext-Audio Out 2	Input 1	Input 2	Input 3	Input 4
Ext-Audio Out 3	Input 1	Input 2	Input 3	Input 4
Ext-Audio Out 4	Input 1	Input 2	Input 3	Input 4

■ Network Page

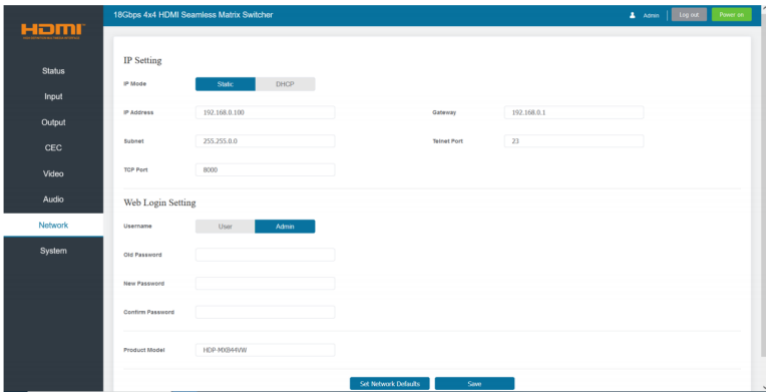

You can do the following operations on the Network page:

① **Modify Network Setting:**

Modify the IP Mode/IP Address/Gateway/Subnet Mask/Telnet Port as required, click “Save” to save the settings, and then it will come into effect.

IP Setting

IP Mode: Static DHCP

IP Address: Gateway:

Subnet: Telnet Port:

TCP Port:

If the Mode is “Static”, you can set manually the IP Address/Gateway/Subnet/Telnet Port as required.

IP Setting

IP Mode: Static | **DHCP**

IP Address: 192.168.0.100 | Gateway: 192.168.0.1

Subnet: 255.255.0.0 | Telnet Port: 23

TCP Port: 8000

If the Mode is “DHCP”, it will search and be filled with the IP Address assigned by the router automatically. You can't modify it now.

② Modify User Password:

Click the “User” button, enter the correct Old Password, New Password, and Confirm Password, and then click “Save”. After successful modification, there will be a prompt, as shown in the following figure:

Web Login Setting

Username: User | **Admin**

Old Password: []

New Password: []

Confirm Password: []

Product Model: H3C-H3044VW

Get Network Defaults | Save

modify successfully!

Confirm

Note: Input rules for changing passwords:

- (1) The password can't be empty.
- (2) New Password can't be the same as Old Password.
- (3) New Password and Confirm Password must be the same.

③ Set the Default Network:

Click “Set Network Defaults”, there will be a prompt, as shown in the following figure:

Reset All Network Configuration to Factory Default?

Cancel | **OK**

Click “OK” to search the IP Address again. After searching is completed, it will switch to the login page, the default network setting is completed.

■ System Page

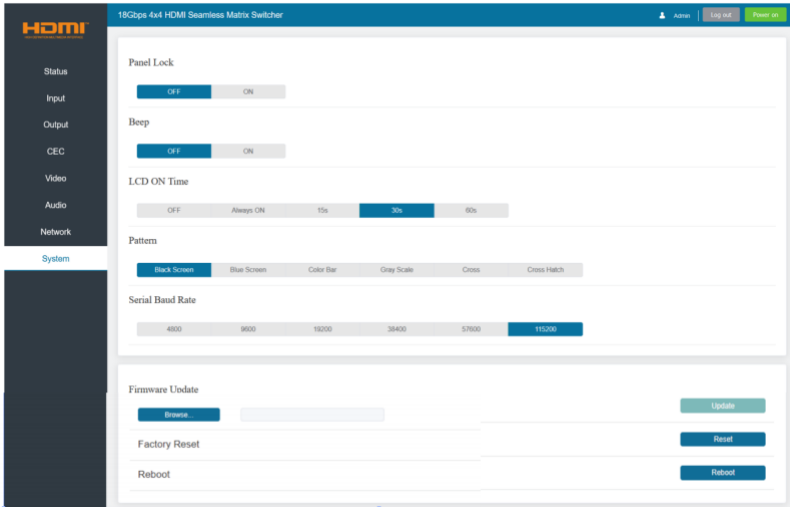

You can do the following operations on the System page:

- ① **Panel Lock:** Click “ON/OFF” to lock/unlock panel buttons. “ON” indicates that panel buttons are unavailable; “OFF” indicates panel buttons are available.
- ② **Beep:** Turn on/off the beep.
- ③ **LCD On Time:** You can set the display duration time (OFF/Always ON/15s/30s/60s).
- ④ **Pattern:** Click to select 6 patterns for the LCD screen.
- ⑤ **Serial Baud Rate:** Click the value to set the Serial Baud Rate.
- ⑥ **Firmware Update:** Click “Browse” to select the update file, and then click “Update” to complete firmware update.
- ⑦ **Factory Reset:** Reset the unit to factory defaults by clicking “Reset”.
- ⑧ **Reboot:** Reboot the unit by clicking “Reboot”.

Note: After reset/reboot, it will switch to the login page.

13. RS-232 Control Command

The product also supports RS-232 control. You need a serial cable with RS-232 male head and DB9 transfer USB male head. The RS-232 head of the serial cable is connected to the RS-232 control port with DB9 at the rear of the Matrix, and the USB head of the serial cable is connected to a PC. The connection method is as follows:

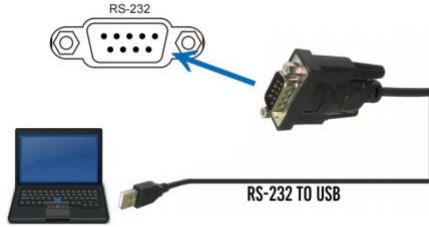

Then, open a Serial Command tool on PC to send ASCII command to control the Matrix. The ASCII command list about the product is shown as below.

ASCII Command				
Serial port protocol. Baud rate: 115200, Data bits: 8bit, Stop bits:1, Check bit: 0				
x - Parameter 1, y - Parameter 2, ! - Delimiter				
Command Code	Function Description	Example	Feedback	Default Setting
System Setting				
help!	List all commands	help!		
r status!	Get device current status	r status!	get the unit all status: power, beep, lock, in/out connection, video/audio crosspoint, edid, scaler, network status	
r type!	Get device model	r type!	4x4 hdmi seamless matrix	
r fw version!	Get firmware version	r fw version!	mcu fw version: x.xx.xx web gui: x.xx.xx	
s power z!	Power on/off the device, z=0~1 (z=0 power off, z=1 power on)	s power 1!	power on system initializing... initialization finished! mcu fw version x.xx.xx	
r power!	Get current power state	r power!	power on /power off	
s beep z!	Enable/disable buzzer function, z=0~1 (z=0 beep off, z=1 beep on)	s beep 1!	beep on beep off	beep off

Command Code	Function Description	Example	Feedback	Default Setting
System Setting				
r beep!	Get buzzer state	r beep!	beep on / beep off	
s lock z!	Lock/unlock front panel button, z=0~1 (z=0 lock off,z=1 lock on)	s lock 1!	panel button lock on panel button lock off	panel button lock off
r lock!	Get panel button lock state	r lock!	panel button lock on/ off	
s lcd on time z!	Set lcd screen remain on time, z=0~4 (0:off 1:always, 2:15s, 3:30s, 4:60s)	s lcd on time 3!	lcd on 30 seconds	lcd on 30 seconds
r lcd mode!	Get the backlight status of lcd screen	r lcd mode!	lcd always on	
s logo1 *****!	Set the logo name displayed on the first line of lcd screen,the max character is 16	s logo1 Matrix Switch!	logo1:Matrix Switch	
s reboot!	Reboot the device	s reboot!	reboot... 4x4 hdmi seamless matrix system initializing... initialization finished! mcu fw version: x.xx.xx web gui: x.xx.xx	
s reset!	Reset to factory defaults	s reset!	reset to factory defaults 4x4 hdmi seamless matrix system initializing... initialization finished! mcu fw version: x.xx.xx web gui: x.xx.xx	
Output Setting				
s display mode x!	Set output display mode (x=0~2) x=0 matrix mode x=1 video wall mode x=2 multi-viewer mode	s display mode 0!	display mode: matrix	matrix
r display mode!	Get output display mode	r display mode!	display mode: matrix	
r output y res!	Get output y resolution (y=0~4) y=0. output all y=1. output 1 y=2. output 2 y=3. output 3 y=4. output 4	r output 1 res!	output 1 resolution: 3840x2160p60	

Command Code	Function Description	Example	Feedback	Default Setting
Output Setting				
s output y res x!	Set output y resolution (y=0~4, x=1~16) y=0. output all y=1. output 1 y=2. output 2 y=3. output 3 y=4. output 4 1. 4096x2160p60, 2. 4096x2160p50, 3. 3840x2160p60, 4. 3840x2160p50, 5. 3840x2160p30, 6. 1920x1080p60, 7. 1920x1080p50, 8. 1920x1080i60, 9.1920x1080i50, 10. 1920x1200p60rb, 11.1360x768p60, 12.1280x800p60, 13.1280x720p60, 14.1280x720p50, 15.1024x768p60, 16. auto	s output 1 res 3!	output 1 resolution: 3840x2160p60	3840x2160p60
s output y csc x!	Set output y color space(y=0~4, x=1~4) y=0. output all y=1. output 1 y=2. output 2 y=3. output 3 y=4. output 4 x=1. rgb444 x=2. ycbcr444 x=3. ycbcr422 x=4. ycbcr420	s output 1 csc 1!	output 1 csc: rgb444	rgb444
r output y csc!	Get output y color space status.(y=0~4) y=0. output all y=1. output 1 y=2. output 2 y=3. output 3 y=4. output 4	r output 1 csc!	output 1 csc: rgb444	
s output y hdcp x!	Set output hdcp (y=0~4, x=1~4) y=0. output all y=1. output 1 y=2. output 2 y=3. output 3 y=4. output 4 x=1. hdcp 1.4 x=2. hdcp 2.2 x=3. follow sink x=4. follow source	s output 1 hdcp 1!	output 1 hdcp: hdcp 1.4	follow sink

Command Code	Function Description	Example	Feedback	Default Setting
Output Setting				
r output y htcp!	Get output y htcp status (y=0~4) y=0. output all y=1. output 1 y=2. output 2 y=3. output 3 y=4. output 4	r output 1 htcp!	output 1 htcp: htcp 1.4	
s output y hmirror x!	Get output y h mirror (y=0~4, x=0,1) y=0. output all y=1. output 1 y=2. output 2 y=3. output 3 y=4. output 4 x=0. h mirror off x=1. h mirror on	s output 1 hmirror 1!	output1 h mirror on	output 1 h mirror off output 2 h mirror off output 3 h mirror off output 4 h mirror off
s output y vmirror x!	Set output y v mirror (y=0~4, x=0,1) y=0. output all y=1. output 1 y=2. output 2 y=3. output 3 y=4. output 4 x=0. v mirror off x=1. v mirror on	s output 1 vmirror 0!	output1 v mirror off	output 1 v mirror off output 2 v mirror off output 3 v mirror off output 4 v mirror off
r output y mirror!	Get output y mirror status (y=0~4) y=0. output all y=1. output 1 y=2. output 2 y=3. output 3 y=4. output 4	r output 0 mirror!	output 1 h mirror on, v mirror off output 2 h mirror on, v mirror off output 3 h mirror on, v mirror off output 4 h mirror on, v mirror off	
s output y stream x!	Set output y stream enable/disable (y=0~4, x=0~1) y=0. output all y=1. output 1 y=2. output 2 y=3. output 3 y=4. output 4 x=0. stream disable x=1. stream enable	s output 1 stream 1!	output 1 stream: enable	enable
r output y stream!	get output y stream status (y=0~4) y=0. output all y=1. output 1 y=2. output 2 y=3. output 3 y=4. output 4	r output 1 stream!	output 1 stream: enable	

Command Code	Function Description	Example	Feedback	Default Setting
Output Setting				
s output bg x!	Set output no signal background display mode (x=1~6) x=1. black screen x=2. blue screen x=3. color bar x=4. gray scale x=5. cross x=6. cross hatch	s output bg 1!	output background: black screen	black screen
r output bg!	Get output no signal background display mode	r output bg!	output background: black screen	
EDID Setting				
s input x edid z!	Set hdmi input x edid mode (x=0~4,z=1~18) x=0. all input x=1. input1 x=2. input2 x=3. input3 x=4. input4 z=1. 4k60,2.0ch z=2. 4k60,5.1ch z=3. 4k60,7.1ch z=4. 4k30,2.0ch z=5. 4k30,5.1ch z=6. 4k30,7.1ch z=7. 1080p,2.0ch z=8. 1080p,5.1ch z=9. 1080p,7.1ch z=10. wuxga,2.0ch z=11. 768p, 2.0ch z=12. xga,2.0ch z=13. user1 z=14. user2 z=15. copy out1 z=16. copy out2 z=17. copy out3 z=18. copy out4	s input 1 edid 1!	input 1 edid:4k60,2.0ch	4k60,2.0ch
r input x edid!	Get input x edid mode (x=0~4) x=0. all input x=1. input1 x=2. input2 x=3. input3 x=4. input4	r input 1 edid!	input 1 edid:4k60,2.0ch	

Command Code	Function Description	Example	Feedback	Default Setting
Video Matrix Setting				
s output y in source x!	Route input source to output y (y=0~4, x=1~4) y=0. output all y=1. output 1 y=2. output 2 y=3. output 3 y=4. output 4 x=1. input 1 x=2. input 2 x=3. input 3 x=4. input 4	s output 1 in source 1!	output1->input1	output1->input1 output2->input2 output3->input3 output4->input4
r output y in source!	Get output y selected input source (y=0~4) y=0. output all y=1. output 1 y=2. output 2 y=3. output 3 y=4. output 4	r output 1 in source!	output1->input1	
Video Wall Setting				
s tw mode x!	Set tv wall display mode (x=1~9) x=1. 2x2 mode x=2. 2x1 mode x=3. 2x1-2 mode x=4. 1x2 mode x=5. 1x2-2 mode x=6. 3x1 mode x=7. 4x1 mode x=8. 1x3 mode x=9. 1x4 mode	s tw mode 1!	tv wall mode: 2x2	tv wall mode: 2x2
r tw mode!	Get tv wall display mode	r tw mode!	tv wall mode: 2x2	
s tw h bezel x!	Set tv wall horizontal bezel (x=0~10,+,-)	s tw h bezel 0!	tv wall horizontal bezel: 0	tv wall horizontal bezel: 0
r tw h bezel!	Get tv wall row bezel	r tw h bezel!	tv wall horizontal bezel: 0	
s tw v bezel x!	Set tv wall vertical bezel (x=0~10,+,-)	s tw v bezel 0!	tv wall vertical bezel: 0	tv wall vertical bezel: 0
r tw v bezel!	Get tv wall vertical bezel	r tw v bezel!	tv wall vertical bezel: 0	
s tw group y input x!	Set tv wall group y display which source input (y=0~4, x=1~4) y=0. tv wall group all y=1. tv wall group 1 y=2. tv wall group 2 y=3. tv wall group 3 y=4. tv wall group 4 x=1. hdmi input 1 x=2. hdmi input 2 x=3. hdmi input 3 x=4. hdmi input 4	s tw group 1 input 1!	tv wall group 1 input: hdmi input 1	tv wall group 1 input: hdmi input 1

Command Code	Function Description	Example	Feedback	Default Setting
Video Wall Setting				
r tw group y source!	Get tv wall group y display which source input (y=0~4) y=0. tv wall group all y=1. tv wall group 1 y=2. tv wall group 2 y=3. tv wall group 3 y=4. tv wall group 4	r tw group 0 source!	tv wall group 1 input: hdmi input 1 tv wall group 2 input: hdmi input 2 tv wall group 3 input: hdmi input 3 tv wall group 4 input: hdmi input 4	
s tw res x!	Set tv wall resolution (x=1~15) 1. 4096x2160p60, 2. 4096x2160p50, 3. 3840x2160p60, 4. 3840x2160p50, 5. 3840x2160p30, 6. 1920x1080p60, 7. 1920x1080i60, 8. 1920x1080i60, 9. 1920x1080i50, 10. 1920x1200p60rb, 11. 1360x768p60, 12. 1280x800p60, 13. 1280x720p60, 14. 1280x720p50, 15. 1024x768p60	s tw res 3!	tv wall resolution: 3840x2160p60	3840x2160p60
r tw res!	Get tv wall resolution	r tw res!	tv wall resolution: 3840x2160p60	3840x2160p60
Multi-viewer Setting				
s multiview x!	Set multi-viewer display mode(x=1~6) x=1. single x=2. pip x=3. dual x=4. triple x=5. quad x=6. user	s multiview 1!	single screen	single screen
r multiview!	Get multi-viewer display mode	r multiview!	single screen	
s window y in x!	Select one input for one window for the current multiview mode (x=1~4, y=0~4) y=0. window all y=1. window 1 y=2. window 2 y=3. window 3 y=4. window 4 x=1. hdmi 1 x=2. hdmi 2 x=3. hdmi 3 x=4. hdmi 4	s window 1 in 1!	window 1 select hdmi 1	

Command Code	Function Description	Example	Feedback	Default Setting
Multi-viewer Setting				
r window y in!	Get windows y selected input source (y=0~4) y=0. window all y=1. window 1 y=2. window 2 y=3. window 3 y=4. window 4	r window in!	window 1 select hmi 1	
s pip position x!	Set pip window position (x=1~4) 1. upper left 2. lower left 3. upper right 4. lower right	s pip position 3!	pip on upper right	pip on upper right
r pip position!	Get pip window position	r pip position!	pip on upper right	
s pip size x!	Set pip window size (x=1~3) 1. small 2. middle 3. large	s pip size 3!	pip size: large	pip size: large
r pip size!	Get pip window size	r pip size!	pip size: large	
s dual x mode!	Set dual windows display mode (x=1) 1. dual 1 mode	s dual 1 mode!	dual 1 mode	dual 1 mode
r dual mode!	Get dual windows display mode	r dual mode!	dual 1 mode	
s triple x mode!	Set triple windows display mode (x=1~3) 1. triple 1 mode 2. triple 2 mode (2pip-left) 3. triple 3 mode (2pip-right)	s triple 1 mode!	triple 1 mode	triple 1 mode
r triple mode!	Get triple windows display mode	r triple mode!	triple 1 mode	
s quad x mode!	Set quad windows display mode (x=1~3) 1. quad 1 mode 2. quad 2 mode 3. quad 3 mode	s quad 1 mode!	quad 1 mode	quad 1 mode
r quad mode!	Get quad windows display mode	r quad mode!	quad 1 mode	
s aspect x!	Set windows display aspect ratio (x=1~2) 1. full screen 2. 16:9	s aspect 1!	aspect: quad 2 full screen	aspect: full screen
r aspect!	Get windows display aspect ratio	r aspect!	aspect: quad 2 full screen	

Command Code	Function Description	Example	Feedback	Default Setting
Multi-viewer Setting				
s user x mode!	Set user define windows display mode (x=1~3) 1. user 1 mode 2. user 2 mode 3. user 3 mode	s user 1 mode!	user 1 mode	user 1 mode
r user mode!	Get user define windows display mode	r user mode!	user1 mode	
s mv output audio x!	Set output audio source (x=0~4) 0. follow window 1 selected source 1. input 1 audio 2. input 2 audio 3. input 3 audio 4. input 4 audio	s mv output audio 0! s mv output audio 1!	output audio: follow window 1 selected source output audio: select input 1 audio	output audio: follow window 1 selected source
r mv output audio!	Get output audio source	r mv output audio!	output audio: follow window 1 selected source	
s mv res x!	Set multi-viewer resolution (x=1~15) 1. 4096x2160p60, 2. 4096x2160p50, 3. 3840x2160p60, 4. 3840x2160p50, 5. 3840x2160p30, 6. 1920x1080p60, 7. 1920x1080p50, 8. 1920x1080i60, 9.1920x1080i50, 10. 1920x1200p60rb, 11.1360x768p60, 12.1280x800p60, 13.1280x720p60, 14.1280x720p50, 15.1024x768p60	s mv res 3!	multi-viewer resolution: 3840x2160p60	3840x2160p60
r mv res!	Get multi-viewer resolution	r mv res!	multi-viewer resolution: 3840x2160p60	3840x2160p60
Embedded Audio Setting				
s input x as z!	Set input x audio selectedsource hdmi or embed analog audio (x=0~4, z=0~1) x=0. all input x=1. input 1 x=2. input 2 x=3. input 3 x=4. input 4 z=0. hdmi original audio z=1. embed analog audio	s input 1 as 1!	input 1 select hdmi original audio	hdmi original audio

Command Code	Function Description	Example	Feedback	Default Setting
Embedded Audio Setting				
r input x as!	Get input x audio selected source hdmi or embed analog audio (x=0~4, z=0~1) x=0. all input x=1. input 1 x=2. input 2 x=3. input 3 x=4. input 4	r input 0 as!	input 1 select hdmi original audio input 2 select hdmi original audio input 3 select embed analog audio input 4 select embed analog audio	
Ext-audio Setting				
s output y exa x!	Set output y ext-audio enable/disable (y=0~4, x=0~1) y=0. output all y=1. output 1 y=2. output 2 y=3. output 3 y=4. output 4 x=0. ext-audio disable x=1. ext-audio enable	s output 1 exa 1!	output 1 ext-audio: enable	enable
r output y exa!	Get output y ext-audio enable/disable status. (y=0~4) y=0. output all y=1. output 1 y=2. output 2 y=3. output 3 y=4. output 4	r output 1 exa!	output 1 ext-audio: enable	
s output exa mode x!	Set output ext-audio mode(x=0~2) x=0. bind to input mode x=1. bind to output mode x=2. matrix mode	s output exa mode 0!	output ext-audio mode: bind to input	bind to output
r output exa mode!	Get output ext-audio mode	r output exa mode!	output ext-audio mode: bind to input	
s output y exa in source x!	Route input source audio x to output ext-audio y (y=0~4, x=1~4) y=0. output all y=1. output 1 y=2. output 2 y=3. output 3 y=4. output 4 x=1. input 1 x=2. input 2 x=3. input 3 x=4. input 4	s output 1 exa in source 1!	output 1 ext-audio ->input 1	output 1 ext-audio->input 1 output 2 ext-audio->input 2 output 3 ext-audio->input 3 output 4 ext-audio->input 4

Command Code	Function Description	Example	Feedback	Default Setting
Ext-audio Setting				
r output y exa in source!	Get output y ext-audio selected input source (y=0~4) y=0. output all y=1. output 1 y=2. output 2 y=3. output 3 y=4. output 4	r output 0 exa in source!	output 1 ext-audio->input 1 output 2 ext-audio->input 2 output 3 ext-audio->input 3 output 4 ext-audio->input 4	
CEC Setting				
s cec in x on!	Set input x power on by cec, x=0~4(0=all input)	s cec in 1 on!	input 1 power on	
s cec in x off!	Set input x power off by cec, x=0~4(0=all input)	s cec in 1 off!	input 1 power off	
s cec in x menu!	Set input x open menu by cec, x=0~4(0=all input)	s cec in 1 menu!	input 1 open menu	
s cec in x back!	Set input x back operation by cec, x=0~4(0=all input)	s cec in 1 back!	input 1 back operation	
s cec in x up!	Set input x menu up operation by cec, x=0~4 (0=all input)	s cec in 1 up!	input 1 menu up operation	
s cec in x down!	Set input x menu down operation by cec, x=0~4(0=all input)	s cec in 1 down!	input 1 menu down operation	
s cec in x left!	Set input x menu left operation by cec, x=0~4(0=all input)	s cec in 1 left!	input 1 menu left operation	
s cec in x right!	Set input x menu right operation by cec, x=0~4(0=all input)	s cec in 1 right!	input 1 menu right operation	
s cec in x enter!	Set input x menu enter by cec, x=0~4(0=all input)	s cec in 1 enter!	input 1 menu enter operation	
s cec in x play!	Set input x play by cec, x=0~4(0=all input)	s cec in 1 play!	input 1 play operation	
s cec in x pause!	Set input x pause by cec, x=0~4(0=all input)	s cec in 1 pause!	input 1 pause operation	
s cec in x stop!	Set input x stop by cec, x=0~4(0=all input)	s cec in 1 stop!	input 1 stop operation	
s cec in x rew!	Set input x rewind by cec, x=0~4(0=all input)	s cec in 1 rew!	input 1 rewind operation	
s cec in x mute!	Set input x volume mute by cec, x=0~4(0=all input)	s cec in 1 mute!	input 1 volume mute	
s cec in x vol-!	Set input x volume down by cec, x=0~4 (0=all input)	s cec in 1 vol-!	input 1 volume down	
s cec in x vol+!	Set input x volume up by cec, x=0~4(0=all input)	s cec in 1 vol+!	input 1 volume up	
s cec in x ff!	Set input x fast forward by cec, x=0~4(0=all input)	s cec in 1 ff!	input 1 fast forward operation	

Command Code	Function Description	Example	Feedback	Default Setting
CEC Setting				
s cec in x previous!	Set input x previous by cec, x=0~4 (0=all input)	s cec in 1 previous!	input 1 previous operation	
s cec in x next!	Set input x next by cec, x=0~4 (0=all input)	s cec in 1 next!	input 1 next operation	
s cec hdmi out y on!	Set hdmi output y power on by cec, y=0~4 (0=all hdmi output)	s cec hdmi out 1 on!	hdmi output 1 power on	
s cec hdmi out y off!	Set hdmi output y power off by cec, y=0~4 (0=all hdmi output)	s cec hdmi out 1 off!	hdmi output 1 power off	
s cec hdmi out y mute!	Set hdmi output y volume mute by cec, y=0~4 (0=all hdmi output)	s cec hdmi out 1 mute!	hdmi output 1 volume mute	
s cec hdmi out y vol-!	Set hdmi output y volume down by cec, y=0~4 (0=all hdmi output)	s cec hdmi out 1 vol-!	hdmi output 1 volume down	
s cec hdmi out y vol+!	Set hdmi output y volume up by cec, y=0~4 (0=all hdmi output)	s cec hdmi out 1 vol+!	hdmi output 1 volume up	
s cec hdmi out y active!	Set hdmi output y active source by cec, y=0~4 (0=all hdmi output)	s cec hdmi out 1 active!	hdmi output 1 active source	
Network Setting				
r ipconfig!	Get the current ip configuration	r ipconfig!	ip mode: static ip: 192.168.0.100 subnet mask: 255.255.255.0 gateway: 192.168.0.1 tcp/ip port=8000 telnet port=23 mac address: 00:1c:91:03:80:01	
r mac addr!	Get network mac address	r mac addr!	mac address: 00:1c:91:03:80:01	
s ip mode z!	Set network ip mode to static ip or dhcp, z=0~1 (z=0 static, z=1 dhcp)	s ip mode 0!	set ip mode:static. (please use "s net reboot!" command or repower device to apply new config!)	
r ip mode!	Get network ip mode	r ip mode!	ip mode: static	
s ip addr xxx.xxx.xxx!	set network ip address	s ip addr 192.168.0.100!	set ip address: 192.168.0.100 (please use "s net reboot!" command or repower device to apply new config!) dhcp on, device can't config static address, set dhcp off first.	

Command Code	Function Description	Example	Feedback	Default Setting
Network Setting				
r ip addr!	Get network ip address	r ip addr!	ip address:192.168.0.100	
s subnet xxx.xxx.xxx.xxx!	Set network subnet mask	s subnet 255.255.255.0!	set subnet mask: 255.255.255.0 (please use "s net reboot!" command or repower device to apply new config!) dhcp on, device can't config subnet mask, set dhcp off first.	
r subnet!	Get network subnet mask	r subnet!	subnet mask:255.255.255.0	
s gateway xxx.xxx.xxx.xxx!	Set network gateway	s gateway 192.168.0.1!	set gateway:192.168.0.1 (please use "s net reboot!" command or repower device to apply new config!) dhcp on, device can't config gateway, set dhcp off first.	
r gateway!	Get network gateway	r gateway!	gateway:192.168.0.1	
s tcp/ip port x!	Set network tcp/ip port (x=1-65535)	s tcp/ip port 8000!	set tcp/ip port:8000	
r tcp/ip port!	Get network tcp/ip port	r tcp/ip port!	tcp/ip port:8000	
s telnet port x!	Set network telnet port (x=1-65535)	s telnet port 23!	set telnet port:23	
r telnet port!	Get network telnet port	r telnet port!	telnet port:23	
s net reboot!	Reboot network modules	s net reboot!	network reboot... ip mode: static ip: 192.168.0.100 subnet mask: 255.255.255.0 gateway: 192.168.0.1 tcp/ip port=8000 telnet port=23 mac address: 00:1c:91:03:80:01	

14. Application Example

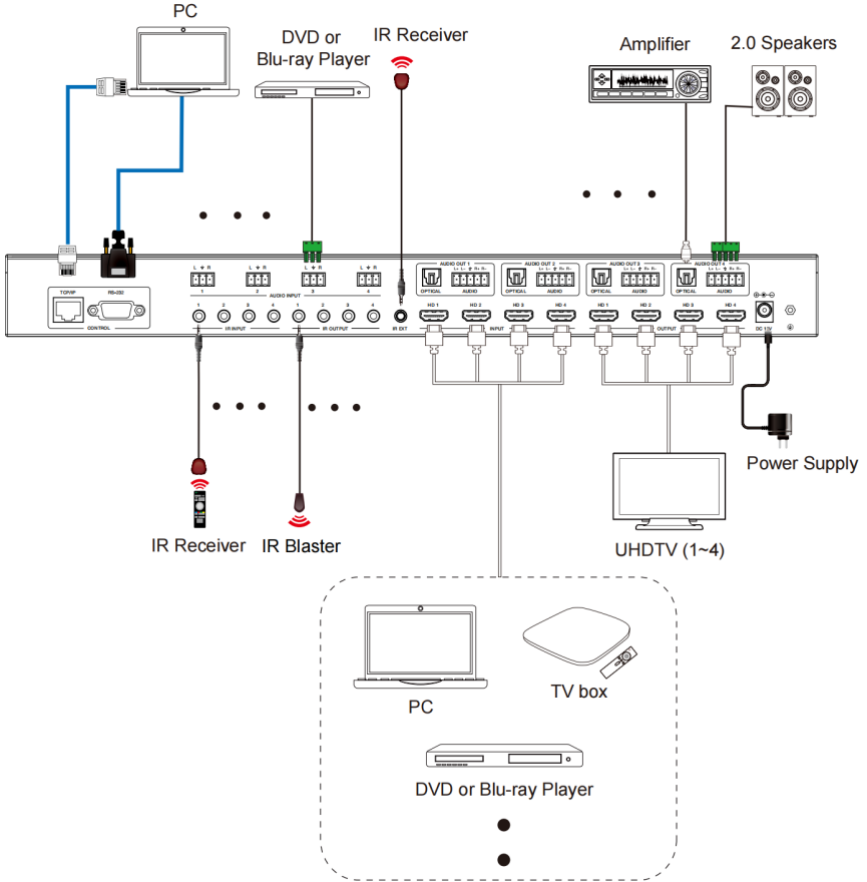

HDMI™
HIGH-DEFINITION MULTIMEDIA INTERFACE

The terms HDMI and HDMI High-Definition Multimedia interface, and the HDMI Logo are trademarks or registered trademarks of HDMI Licensing LLC in the United States and other countries.