

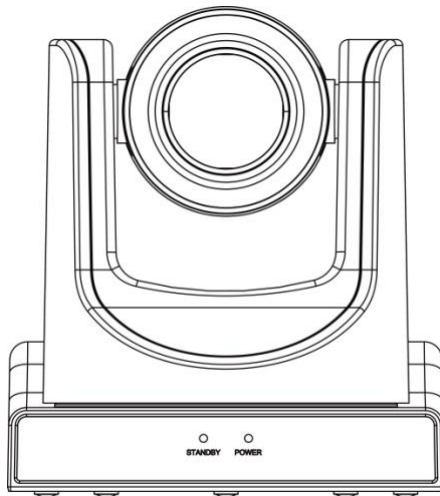

iCam P13/ P13N

1080P PTZ Conference Camera

30x Optical and 8x Digital Zoom



User Manual

www.infobitav.com info@infobitav.com

Catalogue

- 1 Note.....1
- 2 Packing List.....1
- 3 Quick Start1
- 4 About Product3
 - 4.1 Features.....3
 - 4.2 Product Specification3
 - 4.3 Interfaces and Buttons.....4
 - 4.4 Dimension.....5
 - 4.5 Remote Control5
 - 4.6 RS-232 Interface6
 - 4.7 VISCA Network.....7
 - 4.8 Serial Communication Control.....7
- 5 GUI Settings9
 - 5.1 MENU9
 - 5.2 EXPOSURE.....9
 - 5.3 COLOR.....9
 - 5.4 IMAGE10
 - 5.5 P/T/Z10
 - 5.6 NOISE REDUCTION11
 - 5.7 SETUP11
 - 5.8 COMMUNICATION SETUP.....11
 - 5.9 RESTORE DEFAULT.....11
- 6 Network Function12
 - 6.1 Operating Environment.....12
 - 6.2 Equipment Installation.....12
 - 6.3 Internet Connection.....12
 - 6.4 IP camera controlled by LAN.....12
 - 6.4.1 Setup IP address.....12
 - 6.4.2 Visit/Access IP Camera13
 - 6.5 IP Camera controlled by WAN.....13

6.5.1	Setup IPC controlled by dynamic DNS	13
6.5.2	Dynamic DNS visit camera.....	14
6.5.3	VLC stream media player monitoring.....	14
6.6	IP Camera Parameter Setup	14
6.6.1	Homepage Introduction	14
6.6.2	Video Settings.....	16
6.6.3	Image Settings.....	17
6.6.4	Audio Settings.....	17
6.6.5	System Settings	18
6.6.6	Network Settings.....	18
6.6.7	WiFi Settings.....	19
6.6.8	Device Information	19
6.7	Download the Network Upgrade Program.....	19
7	Maintenance and Troubleshooting	19

1 Note

● Electric Safety

Installation and operation must accord with electric safety standard.

● Use caution to transport

Avoid stress, vibration or soakage in transport, storage and installation.

● Polarity of power supply

The power supply of this product is +12V, the max electrical current is 2A. Polarity of the power supply plug drawing shows as below.



● Installation Precautions

Do not grasp the camera lens when carrying it.
 Don't touch camera lens by hand. Mechanical damage may be caused by doing so.
 Do not use in corrosive liquid, gas or solid

environment to avoid any cover (plastic material) damage. Make sure there is no obstacle within rotation range.

Please never power on before installation is completed.

● Do not dismantle the camera

We are not responsible for any unauthorized modification or dismantling.



Warning

Specific frequencies of electromagnetic field may affect the image of the camera!

2 Packing List

When you unpack, check that all the supplied accessories are included:

Name	Quantity
Camera	1
AC Power Adaptor	1
Power Cable	1
RS232 Cable	1
Remote Control	1
User Manual	1

3 Quick Start

1) Please check connections are correct before starting.

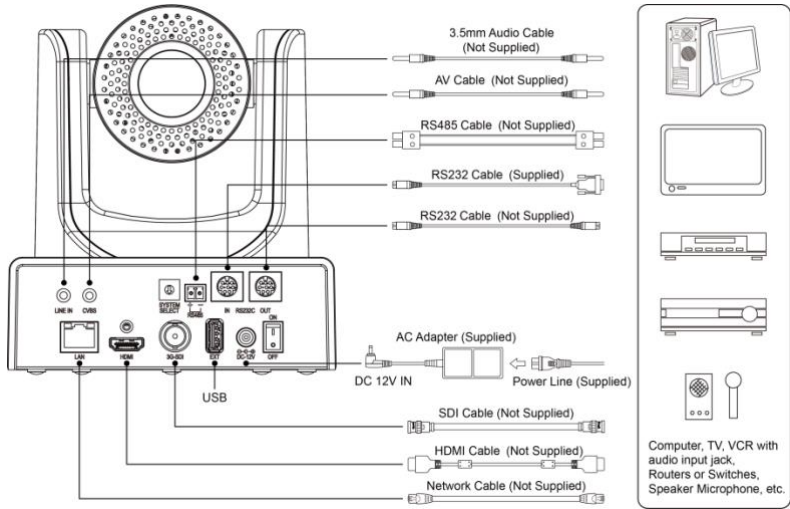

- 2) Connect the power adapter to the power connector on the rear panel of the camera. The power indicator on the front panel of the camera is on.
- 3) After the camera is powered on, it starts to initialize, right up to the limit position, and then both horizontal and vertical go to the middle position, the motor stops running, and the initialization is completed.
(Note: If preset 0 is saved, PTZ will be move to preset 0)

4 About Product

4.1 Features

- **H.265 Encode**

It supports H.265 encode, enabling transmit full HD 1080p video stream by ultra-low bandwidth.

- **1080P Full HD**

Apply Panasonic's high quality HD CMOS sensors of 1/2.7 inch, 2.07 million effective pixels, so as to reach maximum 1920 x 1080 resolution and achieve quality image.

- **Ultra-high Frame Rate**

The output frame rate up to 60fps in 1080P.

- **Multiple Interfaces**

It supports HDMI, 3G-SDI interface, effective transmission distance up to 150 meters (under 1080P30). HDMI, SDI, Network can output at the same time. It also support CVBS interface.

- **30x Optical + 8x Digital Zoom**

High quality super telephoto lens, it supports 30x optical zoom, and 8x digital zoom.

- **AAC Audio Encoding**

Support AAC audio encoding, better sound quality and smaller bandwidth.

- **Local Storage**

Support U disk local storage, local recording directly without NVR.

- **Low Light**

The application of 2D and 3D noise reduction algorithm greatly reduces image noise. Even under the condition of ultra-low illumination, it still keep the picture clean and clear, and the SNR of image is as high as 55dB.

- **Remote Control**

Through the RS232 and RS485 serial ports, the camera can be controlled remotely.

4.2 Product Specification

Model	iCam P13/ P13N
Name	Video Conference Camera
Camera	
Signal System	HD: 1080p/60, 1080p/50, 1080i/60, 1080i/50, 1080p/30, 1080p/25, 720p/60, 720p/50, 720p/30, 720p/25 SD: 480i, 576i
Sensor	1/2.7 inch, CMOS, Effective pixels: 2.07M
Scanning Mode	Progressive
Lens	30x, f4.42mm ~ 132.6mm, F1.8 ~ F2.8
Digital Zoom	8x
Minimum Illumination	0.05 Lux @ (F1.8, AGC ON)
Shutter	1/30s ~ 1/10000s
White Balance	Auto, Indoor, Outdoor, One Push, Manual, VAR
Backlight Compensation	Support
Digital Noise Reduction	2D & 3D Digital Noise Reduction
Signal Noise Ratio	≥55dB
Horizontal Angle of View	60.7° ~ 2.28°
Vertical Angle of View	34.1° ~ 1.28°
Horizontal Rotation Range	±170°

Vertical Rotation Range	-30° ~ +90°
Pan Speed Range	1.7° ~ 100°/s
Tilt Speed Range	1.7° ~ 69.9°/s
H & V Flip	Support
Image Freeze	Support
Local Storage	Support
Number of Preset	255
Preset Accuracy	0.1°

IPC Features	
Video Compression	H.264/H.265/MJPEG
Video Stream	First Stream, Second Stream
First Stream Resolution	1920x1080, 1280x720, 1024x576, 960x540, 640x480, 640x360
Second Stream Resolution	1280x720, 1024x576, 720x576 (50Hz support), 720x480 (60Hz support), 720x408, 640x360, 480x270, 320x240, 320x180
Video Bit Rate	32Kbps ~ 20480Kbps
Bit Rate Type	Variable Rate, Fixed Rate
Frame Rate	50Hz: 1fps ~ 50fps, 60Hz: 1fps ~ 60fps
Audio Compression	AAC
Audio Bit Rate	96Kbps, 128Kbps, 256Kbps
Protocols	TCP/IP, HTTP, RTSP, RTMP, ONVIF, DHCP, Multicast, etc.

Input/Output Interface	
Audio Interface	1 x LINE IN: 3.5mm Audio Interface
CVBS Interface	1 x CVBS: 3.5mm RCA jack, 1Vp-p, 75Ω

Communication Interface	1 x RS-485: 2pin phoenix port, Max Distance: 1200m, Protocol: VISCA / Pelco-D / Pelco-P
	1 x RS232 IN: 8pin Min DIN, Max Distance: 30m, Protocol: VISCA / Pelco-D / Pelco-P
	1 x RS-232 OUT: 8pin Min DIN, Max Distance: 30m, Protocol: VISCA network use only
Network Interface	1 x RJ45: 10/100M Adaptive Ethernet Ports
HDMI Interface	1 x HDMI: Version 1.3
3G-SDI Interface	1 x 3G-SDI: BNC type, 800mVp-p, 75Ω. Along to SMPTE 424M standard
USB Interface	1 x USB2.0: Type A female jack
Power Jack	JEITA type (DC IN 12V)

Physical Parameter	
Input Voltage	DC 12V
Current Consumption	1.0A (Max)
Operating Temperature	-10°C ~ 40°C
Storage Temperature	-40°C ~ 60°C
Power Consumption	12W (Max)
MTBF	>30000h
Size	145.2 x 150.9 x 161.8mm
Net Weight	1.52Kg

4.3 Interfaces and Buttons

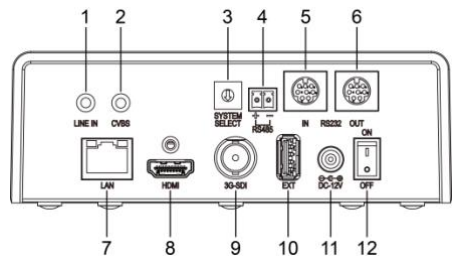

Item	Name
1	LINE IN Interface
2	CVBS Interface
3	System Select Switch
4	RS485 Interface
5	RS232 IN Interface
6	RS232 OUT Interface
7	Network Interface
8	HDMI Interface
9	3G-SDI Interface
10	USB 2.0 Interface
11	DC 12V Interface
12	Power Switch

4.4 Dimension

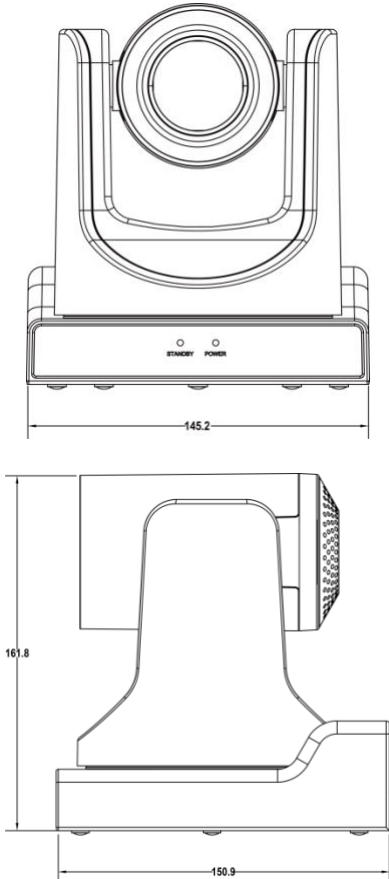

4.5 Remote Control

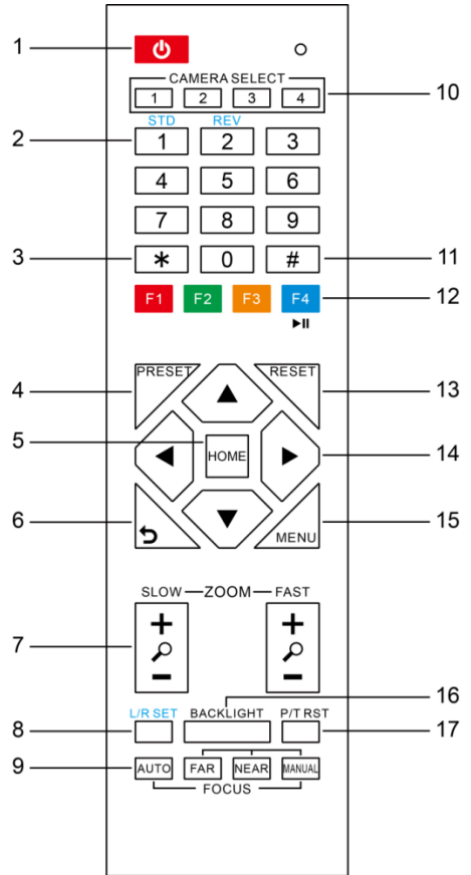

Key Description	
1. Standby Key	Press this button to enter standby mode. Press it again to enter normal mode. Note: Power consumption in standby mode is approximately half of the normal mode
2. Number Key	To set preset or call preset.
3. *Key	Used with other buttons.
4. Preset Key	Set preset: Store a preset position. [SET PRESET] + Numeric button (0-9): Setting a corresponding numeric key preset

position.

5. HOME Key

Confirm menu, enter the submenu or the PTZ will back to the middle position after pressed it

6. Return Key

Return back the last level menu

7. Zoom Key

Slow Zoom: Zoom In [+] or Zoom Out [-] slowly

Fast Zoom: Zoom In [+] or Zoom Out [-] fast

8. Left/Right Setting Key

Press with 1 buttons and 2 buttons setting the direction of the Pan-Tilt.

- Simultaneously press L/R Set +1[STD]: set the Pan-Tilt turn the same direction as the L/R Set.
- Simultaneously press L/R Set +2[REV]: set the Pan-Tilt turn the opposite direction as the L/R Set.

9. Focus Key

Used for focus adjustment.

Press [AUTO] adjust the focuses on the center of the object automatically. To adjust the focus manually.

Press [MANUAL] adjust the focus on the center of the object manual.

MANUAL button, and adjust it with [Far] (Focus on far object) and [NEAR] (Focus on near object).

10. Selection Key

Press the button corresponding to the camera you want to operate with the remote controller.

11. #Key

Used with other buttons.

12. IR Remote Control Key

[*]+[#]+[F1]: Address 1

[*]+[#]+[F2]: Address 2

[*]+[#]+[F3]: Address 3

[*]+[#]+[F4]: Address 4

13. Reset Key

Clear preset: Erase a preset position.

[CLEAR PRESET] + Numeric button (0-9)

Or: [*]+[#]+[CLEAR PRESET]: Erase all the preset individually.

14. PTZ Control Key

Press arrow buttons to perform panning and tilting. Press [HOME] button to face the camera back to front.

15. Menu Key

MENU: enter or exit OSD MENU.

16. Backlight Key

BLC ON/OFF: Press this button to enable the backlight compensation. Press it again to disable the backlight compensation.

NOTE:

- Effective only in auto exposure mode.
- If a light behind the subject, the subject will become dark. In this case, press the backlight ON/OFF button. To cancel this function, press backlight ON/OFF button.

17. PTZ Reset Key

Preset Pan/Tilt self-test.

18. Image Freezing Function

Manually freeze: Open the freezing function after press the remote control [F4], display "Freeze" on the left upper corner character, after five seconds display disappear automatically. If you want to cancel the freeze, press [F4] key and then can return to normal, display "Unfreeze" on the left upper corner, after five seconds display disappear automatically.

Recalling the Preset image Freeze: By the OSD Menu Setting "Recalling the Preset image Freeze" function. After the function is opened, the screen will stay in before Recalling the Preset when Recalling the Preset, the screen can be switched to the preset position screen until the camera points to the preset position.

19. Shortcut Set

[*]+[#]+[1]: OSD menu default English

[*]+[#]+[3]: OSD menu default Chinese

[*]+[#]+[4]: Default IP address

[*]+[#]+[5]: Save OSD

[*]+[#]+[6]: Quickly recover the default

[*]+[#]+[8]: Look the camera version

[*]+[#]+[9]: Quickly set up inversion

4.6 RS-232 Interface

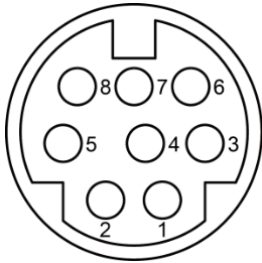

No.	Function
1	DTR
2	DSR
3	TXD
4	GND
5	RXD
6	GND
7	IR OUT
8	NC

The correspondence between the camera and Windows DB-9 pin:

Camera	Windows DB-9
1.DTR	1.CD
2.DSR	2.RXD
3.TXD	3.TXD
4.GND	4.DTR
5.RXD	5.GND
6.GND	6.DSR
7.IR OUT	7.RTS
8.NC	8.CTS
	9.RI

The correspondence between the camera and the Mini DIN pin:

Camera	Mini DIN
1.DTR	1.DTR
2.DSR	2.DSR
3.TXD	3.TXD
4.GND	4.GND
5.RXD	5.RXD
6.GND	6.GND
7.IR OUT	7.NC
8.NC	8.NC

4.7 VISCA Network

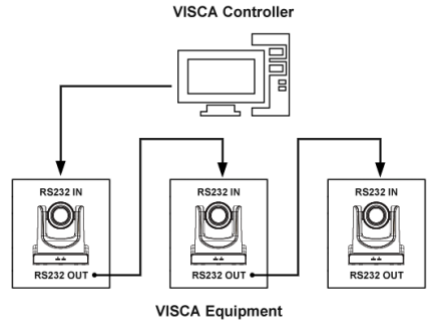

4.8 Serial Communication Control

● RS232 Communication Control

The camera is controlled via RS232. The RS232 serial port parameters are as follows:
 Baud rate: 2400/4800/9600/38400 bit/s;
 Starting Position: 1 bit
 Data bit: 8 bits
 Stop bit: 1 bit
 Check digit: None

● RS485 Communication Control

Control camera via RS485, half duplex mode:
 Baud rate: 2400/4800/9600/38400 bit/s;
 Starting position: 1 bit
 Data bit: 8 bits
 Stop bit: 1 bit
 Check digit: None

After power on, the camera goes to the upper right limit and then back to the middle position. The zoom lens is pulled to the farthest position, auto focus, and the aperture is adjusted to the default value. If the camera has preset 0 saved, the camera will be set to position 0 after the initialization is completed. At this point, the user can use the serial port command to control the camera.

● List of protocols (omitted)

The serial port of the camera follows the VISCA/Pelco-D/Pelco-P standard protocol. If secondary development is required, the camera can be controlled according to the standard protocol.

For a detailed list of VISCA/Pelco-D/Pelco-P protocols, contact the manufacturer.

5 GUI Settings

5.1 MENU

Press [MENU] button to display the main menu on the normal screen, using arrow button to move the cursor to the item to be set. Press the [HOME] button to enter the corresponding sub-menu.

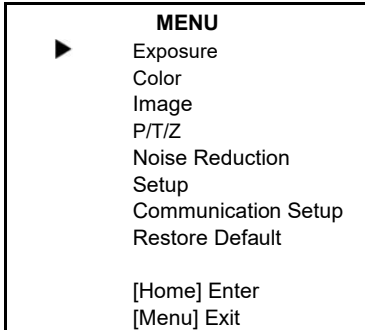

5.2 EXPOSURE

Move the main menu cursor to [EXPOSURE], and press [HOME] key enter the exposure page, as shown in the following figure.

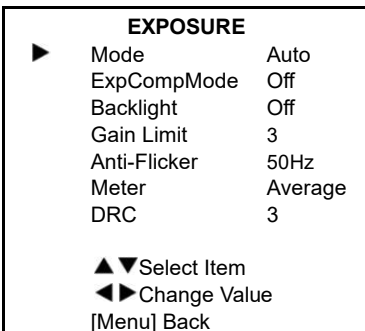

Mode: Exposure mode, optional items: Auto, Manual, SAE, AAE, Bright.

ExpCompMode: Exposure the compensation mode, optional items: On, Off (Effective only in Auto mode).

ExpComp: Exposure the compensation value, optional items: -7~7 (Effective only in ExpCompMode item to On).

Backlight: Set the backlight compensation, optional items: On, Off (Effective only in Auto mode).

Bright: Intensity control, optional items: 0~17 (Effective only in Bright mode).

Gain Limit: Maximum gain limit, optional items: 0~15 (Effective only in Auto, SAE, AAE, Bright mode).

Anti-Flicker: Anti-flicker, optional items: Off, 50Hz, 60Hz (Effective only in Auto, AAE, Bright mode).

Meter: Optional items: Average, Center, Smart, Top.

Iris: Aperture value, optional items: F1.8, F2.0, F2.4, F2.8, F3.4, F4.0, F4.8, F5.6, F6.8, F8.0, F9.6, F11.0, Close (Effective only in Manual, AAE mode).

Shutter: Optional items: 1/30, 1/60, 1/90, 1/100, 1/125, 1/180, 1/250, 1/350, 1/500, 1/725, 1/1000, 1/1500, 1/2000, 1/3000, 1/4000, 1/6000, 1/10000 (Effective only in Manual, SAE mode).

Gain: Optional items: 0 ~ 7 (Effective only in Manual mode).

DRC: DRC strength, optional items: 0 ~ 8.

5.3 COLOR

Move the main menu cursor to [COLOR], and press [HOME] key enter the color page, as shown in the following figure.

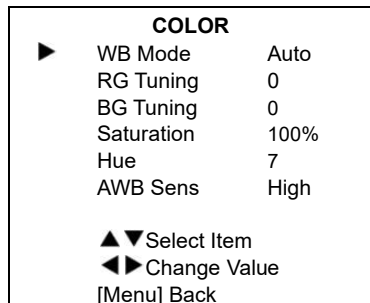

WB-Mode: White balance mode, optional items: Auto, Indoor, Outdoor, One Push, Manual, VAR.

RG Tuning: Red gain fine-tuning, optional items: -10 ~ +10 (Effective only in Auto, One Push, VAR mode).

BG Tuning: Blue gain fine-tuning, optional items: -10 ~ +10 (Effective only in Auto, One Push, VAR mode).

Saturation: Optional items: 60% ~ 200%.

Hue: Optional items: 0 ~ 14.

AWB Sens: The white balance sensitivity, optional items: Low, Middle, High.

RG: Red gain, optional items: 0~255 (Effective only in Manual mode).

BG: Blue gain, optional items: 0~255 (Effective only in Manual mode).

colortemp: Optional items: 2500K ~ 8000K (Effective only in VAR mode).

5.4 IMAGE

Move the main menu cursor to [IMAGE], and press [HOME] key enter the image page, as shown in the following figure.

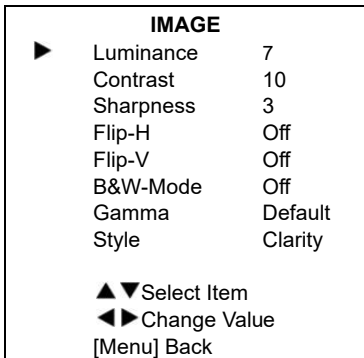

Luminance: Brightness adjustment, optional items: 0 ~ 14.

Contrast: Contrast adjustment, optional items: 0 ~ 14.

Sharpness: Sharpness adjustment, optional items: Auto, 0 ~ 15.

Flip-H: Image flipped horizontally, optional items: On, Off.

Flip-V: Image Flip Vertical, optional items: On, Off.

B&W-Mode: Optional items: On, Off.

Gamma: Optional items: Default, 0.45, 0.5, 0.56, 0.63.

Style: Optional items: Default, Norm, Clarity, Clarity (LED), Bright, Soft, 5S.

5.5 P/T/Z

Move the main menu cursor to [P/T/Z], and press [HOME] key enter the P/T/Z page, as shown in the following figure.

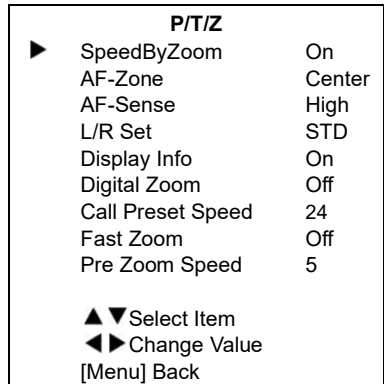

SpeedByZoom: The depth of field scale switch, optional items: On, Off.

AF-Zone: Interested in focusing area, optional items: Top, Center, Bottom.

AF-Sense: Automatic focusing sensitivity options, optional items: Low, Normal, High.

L/R Set: Optional items: STD, REV.

Display Info: Optional items: On, Off.

Digital Zoom: Optional items: Off, 2x, 4x, 8x.

Call Preset Speed: Optional items: 1 ~ 24.

Fast Zoom: Optional items: On, Off.

Pre Zoom Speed: Optional items: 0 ~ 7.

5.6 NOISE REDUCTION

Move the main menu cursor to [NOISE REDUCTION], and press [HOME] key enter the noise reduction page, as shown in the following figure.

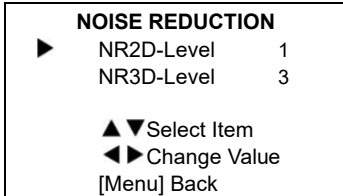

NR2D Level: 2D noise reduction, optional items: Off, Auto, 1 ~ 5.

NR3D Level: 3D noise reduction, optional items: Off, 1 ~ 8.

5.7 SETUP

Move the main menu cursor to [SETUP], and press [HOME] key enter the setup page, as shown in the following figure.

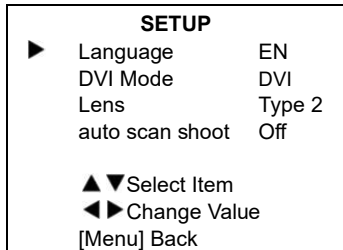

Language: Optional items: EN, Chinese, Russian.

DVI Mode: Optional items: DVI, HDMI.

Lens: Optional items: Type1, Type2.

auto scan shoot: Optional items: On, Off.

5.8 COMMUNICATION SETUP

Move the main menu cursor to [COMMUNICATION SETUP], and press [HOME] key enter the communication setup page, as shown in the following figure.

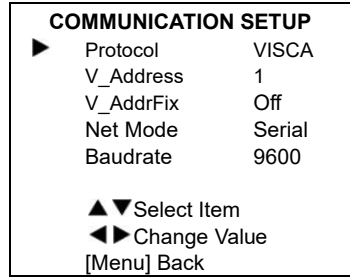

Protocol: Control protocol type, optional items: Auto, VISCA, PELCO-D, PELCO-P.

V_Address: Optional items: 1 ~ 7.

(Effective only in Auto, VISCA protocol).

V_AddrFix: Optional items: On, Off (When set to On, useless in 88 30 01 FF Command).

P_D_Address: Optional items: 0 ~ 254. (Effective only in PELCO-D protocol).

P_P_Address: Optional items: 0 ~ 31. (Effective only in PELCO-P protocol).

Net Mode: Set the serial port network control, optional items: Serial, Paral.

Baudrate: Serial port baud rate, optional items: 2400, 4800, 9600, 38400.

5.9 RESTORE DEFAULT

Move the main menu cursor to [RESTORE DEFAULT], and press [HOME] key enter the restore default page, as shown in the following figure.

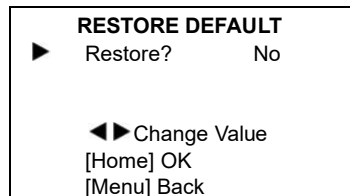

Restore: Confirm restore factory settings, optional items: Yes, No.

Note: Press [HOME] button to confirm, all parameter restore default, include IR Remote address and VISICA address.

6 Network Function

6.1 Operating Environment

Operating System: Windows 2000/2003/XP/vista/7/8/10

Network Protocol: TCP/IP

Client PC: P4/128M RAM/40G HDD/ support scaled graphics card, support DirectX 8.0 or more advanced version.

6.2 Equipment Installation

- 1) Connect internet camera to your internet or to your PC directly via internet cable.
- 2) Turn on DC 12V power.
- 3) If the network connection is normal, the connection light (green) at the network interface will light up within 5 seconds, and the data indicator (orange) will flash, indicating that the physical connection of the camera has been completed.

6.3 Internet Connection

There are two main ways to connect network camera.

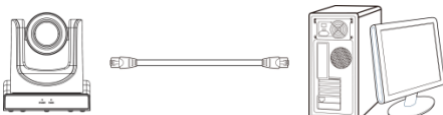

Connect by Network Cable

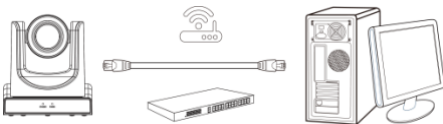

Connect by Switch/Router

6.4 IP camera controlled by LAN

6.4.1 Setup IP address

If you don't know the camera IP, view as below:
 Method 1: Press * and # and 4 on remote controller one by one, the camera IP address will be shown on screen.

Method 2: Connect camera to PC with network cable, use "upgrade_En.exe" to search for IP address.



upgrade

Change IP address, two methods as below:

Method 1: Login the web page, select "Network > Lan Settings", change IP address, subnet mask and gateway. Click "Apply" and restart the camera.

Lan Settings

IP Configuration Type: Fixed IP Address

IP Address: 192.168.100.88

Subnet Mask: 255.255.255.0

Gateway: 192.168.100.1

DNS Address: 8.8.8.8

MAC Address: D4 E0 8E C3 11 CD

Apply Cancel

Port Settings

HTTP Port number: 80 (80)

RTSP Port: 554 (554)

PTZ Port: 5678 (5678)

Control Protocol Settings

Visca Address: 1 (1-7)

Pelco-D Address: 0 (0-255)

Pelco-P Address: 0 (0-31)

RTMP Settings

First stream: On Off Video Audio

MRL: rtmp://192.168.100.138/live/stream0

Second stream: On Off Video Audio

MRL: rtmp://192.168.100.138/live/stream1

RTSP Settings

RTSP Auth: On Off

ONVIF Settings

ONVIF: On Off

ONVIF Auth: On Off

Multicast Settings

Multicast: On Off

Address: 224.1.2.3

Port: 6688

SDK Settings

Active Connection: On Off

Address: 192.168.100.138

Port: 1234

NTP Settings

NTP time sync: On Off

Server address: cn.ntp.org.cn

Time interval: 1440 minutes

Main time show: On Off

Position: X: 0 Y: 0 (0-100)

Sub time show: On Off

Position: X: 0 Y: 0 (0-100)

Method 2: Open “upgrade_En.exe”, change IP and click “Set”. After modified, IP Camera will be restart.

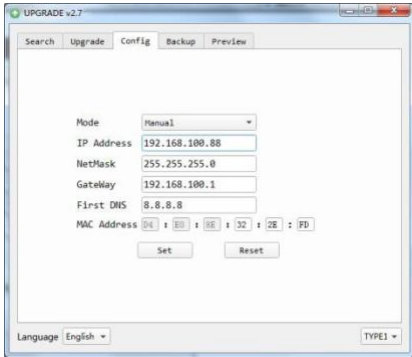

IP camera default IP address “192.168.100.88”, the username is “admin”, password is “admin”.

6.4.2 Visit/Access IP Camera

Input http://192.168.100.88 to IE (better with IE web browser, others will cause little latency), a login window pop up, input login name: admin, password: admin, shown as below:



After login, shown as below:



If user first time use this camera by internet (only for new user), must install a player software (VLC). Please go to VLC website <http://www.videolan.org/vlc/#download> and Install VLC (player software).After installation, login again, will show as above:

6.5 IP Camera controlled by WAN

6.5.1 Setup IPC controlled by dynamic DNS

Two dynamic DNS: Dyndns.org, 3322.org.

Router Port Mapping:

Take Tenda router for example, enter the Router Home Page (interface page), select “Advanced”- “Virtual Server”, add a new port number in “Ext Port”, add a new port number in “Int port”, put camera IP address to “Internal IP”, then select “Save”, shown as below:

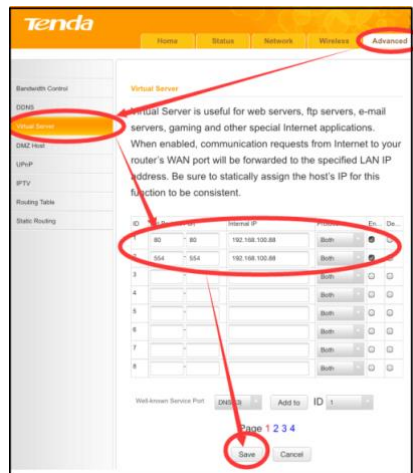

6.5.2 Dynamic DNS visit camera

Set domain name to camera, setup the parameter, then dynamic DNS can access camera. Access link: `http://hostname: port number`. For example, setup host computer name: `youdomain.f3322.org`, the camera port number is 89, the access link should be <http://youdomain.3322.org:89>.



Tips

If the camera port default is 80, then unnecessary to input port number, use host name can access camera directly.

6.5.3 VLC stream media player monitoring

Visit VLC media server procedure

Step 1 Open VLC media player.

Step 2 Click “Media > Open Network Stream”, or click “Ctrl + N”; as below:

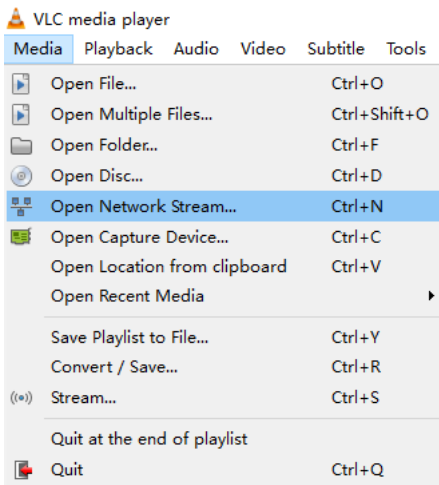

Step 3 Input URL address:

`rtsp://ip: port number/1` (First stream);

`rtsp://ip: port number/2` (Second stream).

Step 4 Finish.



Tips

RTSP port number default 554.

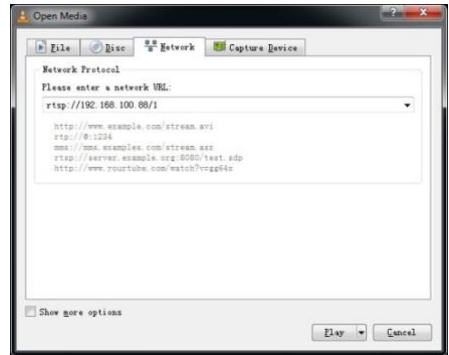

6.6 IP Camera Parameter Setup

6.6.1 Homepage Introduction

Menu

All pages include two menu bars:

Real time monitoring: displaying video image

Parameter setup: with function buttons.

A. Video viewing window

Video viewing window must be same as video resolution, the bigger the resolution is, the bigger the playing area is. Double click viewing window, will show full-screen, double click again, will return to initialized size.

Status bar in viewing window shown as below:



- 1) Video playback pause button: control real-time video pause, stop the last picture, click recoverable video again.
- 2) Audio control buttons: can set silent mode.
- 3) Full screen switch button.

B. PTZ Setup

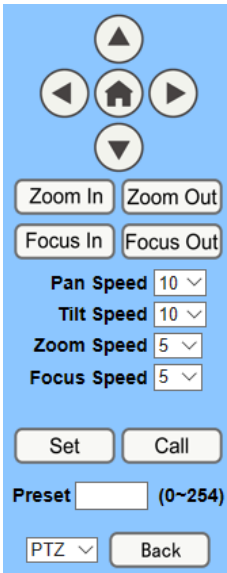

PTZ direction control box: Up, down, left, right, home button as above.

Rate: Pan Speed can be chosen as 1 ~ 24, Tilt Speed can be chosen as 1 ~ 20.

Select corresponding speed and click direction button to realize PTZ speed up or speed down. Zoom In/Zoom out: For zooming in or zooming out. Focus In/Focus Out: Focusing on distant the objects or focusing on close the objects.

Set/Call: When PTZ turn to expected position, can set up preset that user want as below.

Method 1: Type a number into the Preset box.



Method 2: Type the name into the Presets Information.

Presets Information		
No.	Name	
1	<input type="text"/>	Set
2	<input type="text"/>	Set
3	<input type="text"/>	Set
4	<input type="text"/>	Set
5	<input type="text"/>	Set
6	<input type="text"/>	Set
7	<input type="text"/>	Set
8	<input type="text"/>	Set
9	<input type="text"/>	Set

Click "Set" button, when PTZ turn to other position, click "Call" button or click "No." of the Presets Information, PTZ will turn back to preset position.

PTZ / MENU: When system in menu mode, OSD menu display in the upper corner of the image page. PTZ direction control box: Up/down button select menu, and the home button enter the submenu, the left/right button modify the submenu. After the menu to be modified, select PTZ. If in the main menu, save the setting and exit automatically. Otherwise, return to the previous menu.

PTZ: system in PTZ mode.

C. Language selection

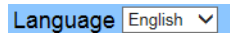

Chinese/English/Russian

6.6.2 Video Settings

Video Settings

Video Format: ▾

Encode Level: ▾

First stream

Encode Protocol: ▾

Resolution: ▾

Bit Rate: (32~20480) kbps

Frame Rate: ▾ fps

I Key Frame Interval: (2~150)

Bit Rate Control: CBR VBR

Fluctuate Level: ▾

Slice Split Enable: On Off

Split Mode: Fixed blocks Fixed bytes

Slice Size: blocks/bytes

Second stream

Encode Protocol: ▾

Resolution: ▾

Bit Rate: (32~6144) kbps

Frame Rate: ▾ fps

I Key Frame Interval: (2~150)

Bit Rate Control: CBR VBR

Fluctuate Level: ▾

Slice Split Enable: On Off

Split Mode: Fixed blocks Fixed bytes

Slice Size: blocks/bytes

1) Video Format

Support 50Hz (PAL) and 60Hz (NTSC), and Dial Priority three formats.

2) Encode Level

Support baseline, mainprofile, highprofile and svc-t four levels.

3) Encode Protocol

Support H.264, H.265 and MJPEG three formats.

4) Resolution

First stream support 1920x1080, 1280x720, 1024x576, 960x540, 640x480, 640x360. Second stream support 1280x720, 1024x576, 720x576 (50Hz support), 720x480 (60Hz support), 720x408, 640x360, 480x270, 320x240, 320x180; The bigger resolution is, the clearer the image will be, more network bandwidth will be taken.

5) Bit Rate

The user can specify the bit rate. Generally speaking, the larger of the bit rate, the clearer of the image. However, the configuration of the bit rate needs to be combined with the network bandwidth. When the network bandwidth is narrow and the bit rate is configured larger, the video stream cannot be transmitted normally, and the visual effect is worse.

6) Frame Rate

User can specify the size of the frame rate, generally, the frame rate greater, the image more smooth; Frame rate is smaller, the more sense of beating.

7) I Key Frame Interval

Set interval between 2 I frame, the bigger interval is the response will be lower from viewing window.

8) Bit Rate Control

Code stream control way:

Constant Bit Rate: Video coder will be coding according to preset speed.

Variable Bit Rate: Video coder will adjust the speed based on preset speed to gain the best image quality.

9) Fluctuate Level

Restrain the fluctuation magnitude of variable rate, grade 1 ~ 6.

10) Slice Split Enable

Enable or disable slice split function.

11) Split Mode

Select split mode, optional items: Fixed blocks, Fixed bytes.

12) Slice Size

Set the size of slice.

6.6.3 Image Settings



1) Brightness

Image bright 0~14, slider control, on the right shows the corresponding numerical.

Default value is 7.

2) Saturation

Saturation 0~14, slider control, on the right shows the corresponding numerical.

Default value is 4.

3) Contrast

Contrast 0~14, slider control, on the right shows the corresponding numerical.

Default value is 10.

4) Sharpness

Sharpness 0~15, slider control, on the right shows the corresponding numerical.

Default value is 3.

5) Hue

Hue 0~14, slider control, on the right shows the corresponding numerical.

Default value is 7.

6) Flip & Mirror

Tick Flip to realize image upside down, tick mirror to realize image around the mirror.

Default value is not tick.

6.6.4 Audio Settings

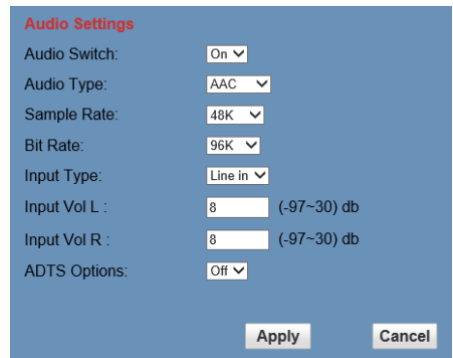

1) Audio Switch

Enable or disable audio switch.

2) Audio Type

Audio type AAC.

3) Sample Rate

Sample rate 44.1K and 48K selectable.

4) Bit Rate

Bit rate 96K, 128K, 256K selectable.

5) Input Type

Input type line in.

6) Input Vol L

The volume of the left channel.

7) Input Vol R

The volume of the right channel.

8) ADTS Options

Optional items: On, Off.

6.6.5 System Settings

1) Work Mode

The default work mode is RTSP.

Optional items: RTSP, SDK, Multicast.

2) Reboot

Click the “Reboot” button, system restart.

3) Username and password

The user can modify the password (letters and Numbers only).

6.6.6 Network Settings

1) Lan Settings

Default the IP address is 192.168.100.88, the MAC address can not be modified.

2) Port Settings

A. HTTP Port

IP address identifies the network device, the device can run multiple web applications, each network program using network port to transmit data, so data transmission to be carried out between the port and port. Port setting is to set up web server program using which port to transmit. When port mapping, need to be consistent with the port number (default port: 80).

B. RTSP Port

Network camera support RTSP protocol, use the VLC tools broadcast.

C. PTZ Port

Support PTZ protocol, default port: 5678.

3) Control Protocol Settings

Setting the camera control communication protocol, include Visca address, Pelco-D address and Pelco-P address.

4) RTMP Settings

Setting the MRL of RTMP, select enable or disable video and audio. You can select control code stream of “On”, “Off”, “Video”, “Audio” between in the two stream.

5) RTSP Settings

Turn On/Off RTSP auth.

6) ONVIF Settings

Turn On/Off ONVIF and ONVIF auth.

7) Multicast Settings

Turn On/Off multicast. Setting the multicast address (default value is 224.1.2.3) and port (default value is 6688, then 6688 is the multicast port of the first stream; 6690 is the multicast port of the second stream).

8) SDK Settings

Turn On/Off active connection. Setting SDK address (default value is 192.168.100.138) and port (default value is 1234).

9) NTP Settings

Turn On/Off NTP time sync, main time show and sub time show. Setting NTP server address, time interval, main stream position and sub stream position.

6.6.7 WiFi Settings

1) Wireless Status

Display the status of wireless network card.

2) Select the network

Search and select the wireless network.

3) SSID

Display the ID of the wireless network.

4) Password

Input the wireless network password, and the password will be displayed when the “show” check box is checked.

5) Connect Status

Display the status of wireless network connect.

6) IP Configuration Type

Select IP Configuration Type, optional items:

Fixed IP Address, Dynamic IP Address.

7) IP Address

Display the IP Address, you can also input the IP Address when you select IP Configuration Type be Fixed IP Address.

8) Subnet Mask

Display the Subnet Mask, you can also input the Subnet Mask when you select IP Configuration Type be Fixed IP Address.

9) Gateway

Display the IP Address of gateway, you can also input the IP Address of gateway when you select IP Configuration Type be Fixed IP Address.

10) DNS Address

Display the DNS Address, you can also input the DNS Address when you select IP Configuration Type be Fixed IP Address.

6.6.8 Device Information

Display the current device information, as shown below.

6.7 Download the Network Upgrade Program

If you need the camera upgrade program, please contact the manufacturer.

7 Maintenance and Troubleshooting

Camera Maintains

- If camera will not be used for a long time, please turn off the power switch, disconnect AC power cord of AC adaptor to

the outlet.

or object near the camera.

- Use soft cloth or tissue to clean the camera cover.
- Please use the soft dry cloth to clean the lens. If the camera is very dirty, clean it with diluted neuter detergent. Do not use any type of solvents, which may damages the surface.

Unqualified Application

- No shooting extreme bright object for a long period of time, such as sunlight, light sources, etc.
- No operating in unstable lighting conditions, otherwise image will be flickering.
- No operating close to powerful electromagnetic radiation, such as TV or radio transmitters, etc.

Troubleshooting

Image

- The monitor shows no image
 - 1) Check that the camera power supply is connected, the voltage is normal, and the power indicator light is always on.
 - 2) Turn off the power switch to check whether the camera is self-testing.
 - 3) Check the cable of video platform and TV whether correct connection.

- Sometimes without the image

Check the cable of video platform and TV whether correct connection.

- Image have jitter when the camera lens at max multiple
 - 1) Check whether the camera installed position be stabled.
 - 2) Check whether have vibrating machinery

- There is no video image in IE Browser

Please visit VLC website

(<http://www.videolan.org/vlc>) download and install VLC media player, after it installed, visit IP Camera will have normal image display.

- Unable to Access IP Camera through IE Browser

- 1) Using PC to access the network to test whether the network access can work properly, first of all, the network fault caused by the PC virus can be eliminated, until the PC and IP Camera can communicate with each other Ping.
- 2) Disconnect the network, connect IP Camera and PC separately, and reset the IP address of PC.
- 3) Check IP address, subnet mask, and gateway settings for IP Camera.
- 4) Check whether the MAC address is conflicts.
- 5) Check whether the web port is occupied by another device.

- Forget the IP address or login password

Please remember (The default IP address: 192.168.100.88; default user name: admin; default password: admin).

Control

- Remote control can not control

- 1) Check and replace the new battery for the remote controller.
- 2) Check whether the camera working mode is correct.
- 3) Check whether the address of remote control can match the camera.

- Series port can not control

- 1) Check whether the camera protocol, address such is the same.
- 2) Check whether the control line is connected well.

www.infobitav.com
info@infobitav.com