



iTrans E100UC

18G HDMI Extender over HDBaseT 3.0 with USB 2.0

Designed for UC



All Rights Reserved

Version: V1.0

www.infobitav.com

info@infobitav.com

Product Introduction

Thanks for choosing the iTrans E100UC 18G HDMI Extender, which consists of a transmitter and a receiver. It can extend 4K60Hz or 1080p video to distance up to 328 feet (100 meters) over a single CAT6A cable without compression. It supports audio de-embedding and ARC. It also supports bi-directional IR, USB and RS232 pass-through control and Ethernet extension. 24V PoC feature allows the transmitter and the receiver can be powered from each other and only one power adapter is needed in system.

Features

- 18Gbps high bandwidth, HDMI V2.0.
- HDMI video resolution up to **4K@60Hz 4:4:4**, HDR10, Dolby Vision.
- Supports HDCP bypass and HDCP 2.2 compliant.
- **HDBaseT 3.0** solution which supports extending signal without compression.
- Extends 4K or 1080p video signals to distances up to 328 feet (**100 meters**) over a single CAT6A cable.
- Bi-directional IR, USB and RS232 pass-through control and Ethernet extension.
- Supports bi-directional 24V PoC.
- Supports audio de-embedding and **ARC** (Audio Return Channel).
- Provides HDMI loop out on transmitter.

Packing List

- 1x TPUH640T Transmitter
- 2x TX Mounting Ears with 2 Screws
- 4x Plastic Cushion
- 1x Power Adapter (24V DC 1.25A)
- 1x TPUH640R Receiver
- 2x RX Mounting Ears with 2 Screws
- 4x Plastic Cushion
- 1x User Manual

Note: Please contact your distributor immediately if any damage or defect in the components is found.

Panel Description

Transmitter Front Panel

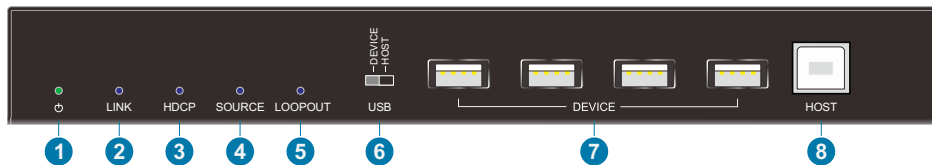

- ① **POWER LED:** Illuminates green when power is applied, or blinks when in firmware upgrade mode.
- ② **LINK LED:** Illuminates when there is a valid HDBaseT link between the transmitter and the receiver.
- ③ **HDCP LED:** Illuminates when the video contains HDCP content, or blinks when the video has no HDCP content.
- ④ **SOURCE LED:** Illuminates when there is an HDMI source device is connected to HDMI input port.
- ⑤ **LOOPOUT LED:** Illuminates when both HDMI source device and HDMI display device (HDMI loop out port) are connected.
- ⑥ **USB:** DIP switch for DEVICE or HOST mode selection.
 - **DEVICE:** The USB devices at transmitter position are used to control the HOST PC at receiver position.
 - **HOST:** The HOST PC at transmitter position is controlled by the USB devices at receiver position.
- ⑦ **DEVICE:** Four type-A USB 2.0 ports for USB devices (e.g. Mouse, Keyboard and Camera) connection to control the PC which is connected to the HOST port of receiver.
- ⑧ **HOST:** Type-B USB 2.0 port for PC connection. The PC can be controlled by the USB devices which are connected to type-A USB 2.0 ports of receiver.

Transmitter Rear Panel

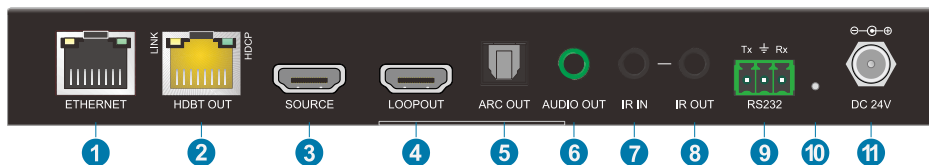

- ① **ETHERNET:** Used for Ethernet extension together with the ETHERNET port of receiver.
- ② **HDBT OUT:** RJ45 port to connect the HDBT input port of receiver by CAT6A Ethernet cable. The LINK LED illuminates when there is a valid HDBaseT link between the transmitter and the receiver. The HDCP LED illuminates when the video contains HDCP content.
- ③ **SOURCE:** Connects to HDMI source device.
- ④ **LOOPOUT:** Connects to HDMI display device.
- ⑤ **ARC OUT:** Connects to audio player (e.g. amplifier) for ARC audio output.
- ⑥ **AUDIO OUT:** Connects to audio player (e.g. amplifier) for audio de-embedding from HDMI input.
- ⑦ **IR IN:** Connects to the IR receiver for IR pass-through.
- ⑧ **IR OUT:** Connects to the IR emitter for IR pass-through.
- ⑨ **RS232:** Connects to RS232 control device (e.g. PC) or a third-party device for RS232 control.
- ⑩ **FIRMWARE UPGRADE BUTTON:** Press the button with paper clip or other sharp tool for 3s to enter firmware upgrade mode. Press the button for 3s again can exit the mode.
- ⑪ **DC 24V:** DC connector for the power adapter connection.

Receiver Front Panel

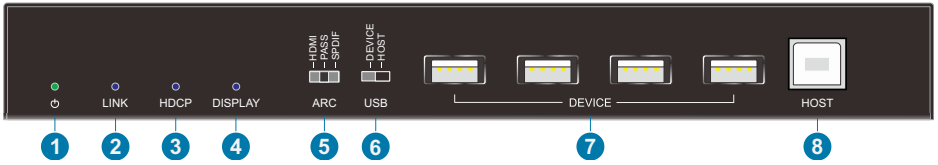

- ① **POWER LED:** Illuminates green when power is applied, or blinks when in firmware upgrade mode.
- ② **LINK LED:** Illuminates when there is a valid HDBaseT link between the transmitter and the receiver.
- ③ **HDCP LED:** Illuminates when the video contains HDCP content, or blinks when the video has no HDCP content.
- ④ **DISPLAY LED:** Illuminates when there is a HDMI display device is connected to HDMI output port and when input source is detected.
- ⑤ **ARC:** DIP switch for ARC mode selection.
 - **HDMI:** The ARC input via HDMI output port of receiver.
 - **PASS:** Supports CEC & ARC pass-through.
 - **SPDIF:** The ARC input via SPDIF input port of receiver.
- ⑥ **USB:** DIP switch for DEVICE or HOST mode selection.
 - **DEVICE:** The USB devices at receiver position are used to control the HOST PC at transmitter position.
 - **HOST:** The HOST PC at receiver position is controlled by the USB devices at transmitter position.
- ⑦ **DEVICE:** Four type-A USB 2.0 port for USB devices (e.g. Mouse, Keyboard and Camera) connection to control the PC which is connected to the HOST port of transmitter.
- ⑧ **HOST:** Type-B USB 2.0 ports for PC connection. The PC can be controlled by the USB devices which are connected to type-A USB 2.0 ports of transmitter.

Receiver Rear Panel

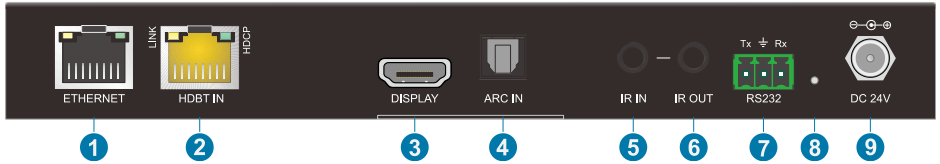

- ① **ETHERNET:** Used for Ethernet extension together with the ETHERNET port of transmitter.
- ② **HDBT IN:** RJ45 port to connect the HDBT output port of transmitter by CAT6A Ethernet cable. The LINK LED illuminates when there is a valid HDBaseT link between the transmitter and the receiver. The HDCP LED illuminates when the video contains HDCP content.
- ③ **DISPLAY:** Connects to HDMI display device.
- ④ **ARC IN:** Connects to ARC audio source device (e.g. TV).
- ⑤ **IR IN:** Connects to the IR receiver for IR pass-through.
- ⑥ **IR OUT:** Connects to the IR emitter for IR pass-through.
- ⑦ **RS232:** Connects to RS232 control device (e.g. PC) or a third-party device which is to be controlled.
- ⑧ **FIRMWARE UPGRADE BUTTON:** Press the button with paper clip or other sharp tool for 3s to enter firmware upgrade mode. Press the button for 3s again can exit the mode.
- ⑨ **DC 24V:** DC connector for the power adapter connection.

System Connection

- 1) When ARC switch is selected to HDMI, and the TV supports ARC, the TV audio can be transmitted back to the transmitter via HDMI output port of receiver, and then it will be output by the **ARC OUT & HDMI Source** port of transmitter. CEC pass-through is not supported in this mode.
- 2) When ARC switch is selected to SPDIF, the audio can be transmitted back to the transmitter via ARC IN port of receiver, and then it will be output by the **ARC OUT & HDMI Source** port of transmitter. Besides, it also supports CEC pass-through in this mode.
- 3) When ARC switch is selected to PASS, the extender can pass the ARC signal and support CEC pass-through. If the amplifier can work with the TV for ARC function, the ARC audio can be transmitted back to the transmitter via HDMI output port of receiver, and then it will be output by the **ARC OUT & HDMI Source** port of transmitter.

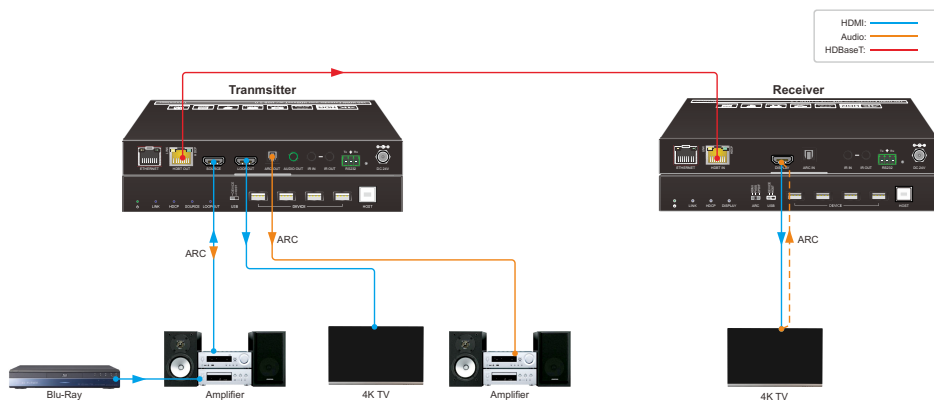

Note: Please try to restart the extender if ARC function works abnormally.

- 4) BYOD PC or Dedicated Room PC mode connection

BYOD PC mode

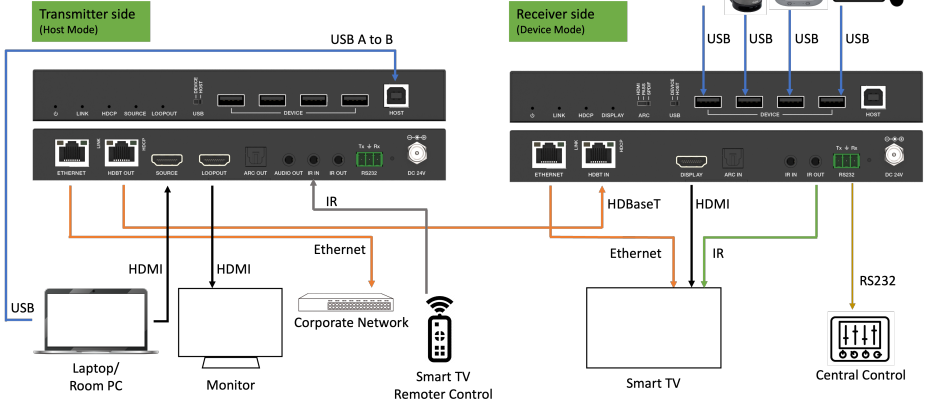

Dedicated Room PC mode

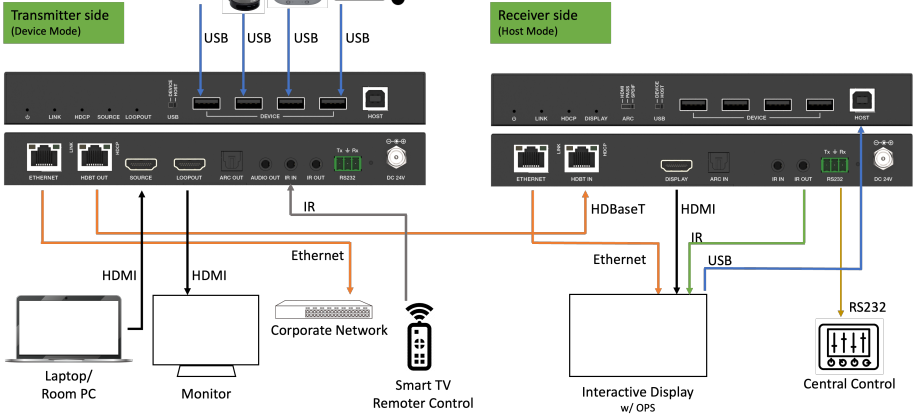

Technical Specification

	Transmitter	Receiver
Video		
Input	(1) SOURCE	(1) HDBT IN
Input Connector	(1) Type-A female HDMI	(1) RJ45
Input Resolution	Up to 4K@60Hz 4:4:4	
Output	(1) HDBT OUT, (1) LOOP OUT	(1) DISPLAY
Output Connector	(1) RJ45, (1) Type-A female HDMI	(1) Type-A female HDMI
Output Resolution	Up to 4K@60Hz 4:4:4	Up to 4K@60Hz 4:4:4
Audio		
Input	-	(1) ARC IN
Input Connector	-	(1) Toslink Connector
Output	(1) ARC OUT, (1) AUDIO OUT	-
Output Connector	(1) Toslink connector (1) 3.5mm jack	-
Audio Format	Toslink (ARC): PCM, Dolby Digital, DTS 5.1CH 3.5mm Audio: PCM 2CH	
Frequency Response	20Hz ~ 20KHz, ± 3 dB	
Max Output Level	2.0Vrms \pm 0.5dB. 2V = 16dB headroom above -10dBV (316mV) nominal consumer line level signal	
THD+N	< 0.05% (-80dB), 20Hz~20KHz bandwidth, 1kHz sine at 0dBFS level (or max level)	
SNR	> 85dB, 20Hz-20kHz bandwidth	
Crosstalk Isolation	> 70dB, 10kHz sine at 0dBFS level (or max level before clipping)	
L-R Level Deviation	< 0.3dB, 1kHz sine at 0dBFS level (or max level before clipping)	
Frequency Response Deviation	< \pm 0.5dB, 20Hz – 20kHz	
Output Load Capability	1K Ω and higher (Supports 10x paralleled 10K Ω loads)	
Stereo Channel Separation	>70dB@1KHz	
Control		
Control Part	(4) DEVICE, (1) HOST, (1) USB Switch, (1) IR IN, (1) IR OUT, (1) RS232, (1) ETHERNET	(4) DEVICE, (1) HOST, (1) ARC Switch, (1) USB Switch, (1) IR IN, (1) IR OUT, (1) RS232, (1) ETHERNET
Control Connector	(4) Type-A USB 2.0, (1) Type-B USB 2.0, (1) 2-pin DIP Switch, (2) 3.5mm Jacks,	(4) Type-A USB 2.0, (1) Type-B USB 2.0, (2) 3-pin DIP Switch, (2) 3.5mm Jacks,

	(1) 3-pin Terminal Block, (1) RJ45	(1) 3-pin Terminal Block, (1) RJ45
General		
Bandwidth	18Gbps	
HDMI Standard	2.0	
HDCP Version	Input: HDCP 2.2, HDCP 1.4 compliant Loopout: Follows the display's HDCP version. RX Output: Follows the source's HDCP version.	
CEC	Pass-through (when ARC switch is selected to PASS or SPDIF)	
Bi-directional PoC	Supported	
HDMI V2.0 Cable Length	4K@60Hz 4:4:4 ≤ 5m, 4K@60Hz 4:2:0 ≤ 15m, 1080P ≤ 20m	
Transmission Standard	HDBaseT	
Transmission Distance	4K/1080p ≤ 328 feet (100 meters)	
Operation Temperature	-5 to +55°C (+23° to +131°F)	
Storage Temperature	-25 to +70°C (-13° to +158°F)	
Relative Humidity	10% to 90%, Non-condensing	
Power Supply	Input:100V~240V AC; Output:24V DC 1.25A	
Power Consumption	17W (Max)	
Dimension (W*H*D)	200mm x 25mm x 100mm(TX); 200mm x 25mm x 100mm(RX)	
Net Weight	540g(TX), 540g(RX)	

Note: Please use high-qualified HDMI cable fully compliant with HDMI V2.0 for reliable transmission and connection.